



Straumann® synOcta® Prosthetic System

Basic Information

About this guide

The Basic Information on the Straumann® synOcta® Prosthetic System provides dental practitioners and related specialists with the essential steps required for the fabrication and insertion of prosthetic restorations for Straumann® Soft Tissue Level Implants.

It is assumed that the user is familiar with placing dental implants. For further information, please see the *Straumann® Dental Implant System, Basic Information (152.754/en)* and other existing Straumann procedure manuals that are referred throughout this document.

Contents

1 Introduction	2
2 Advantage	3
3 synOcta® Abutments – Overview	6
4 Impression procedure with the synOcta® prosthetic system	7
4.a Closed-tray impression procedure “Screwed”	8
4.b Closed-tray impression procedure “Snap-on”	10
4.c Open-tray impression procedure “Screwed”	12
5 Bite registration	14
6 Temporary restorations	15
7 Fabricating the master cast	18
8 Case planning with the Prosthetic Planning Kit	20
9.a synOcta® 1.5 Screw-retained	23
Abutments for transocclusal screw-retained crowns and bridges	23
9.b synOcta® Cemented	30
Abutments for cement-retained crowns and bridges	30
Conventional casting and pressing workflow	30
Digital workflow (CAD/CAM)	35
9.c synOcta® Angled for RN	37
15° and 20° Angled Abutments for screw-retained and cement-retained crowns and bridges	37
9.d synOcta® Angled for WN	42
15° Angled Abutment for cement-retained crowns and bridges	42
9.e synOcta® Transversal (TS for RN)	46
Abutment for Transversal Screw-retained crowns and bridges	46
9.f Straumann® CARES® Implant-borne prosthetics	55
Customized implant prosthetics	55
10 synOcta® Gold Abutment for RN and WN	56
The customizable one-piece solution for anterior zone esthetics	56
11 Processing instructions	66
12 Important guidelines	77

1 Introduction

The synOcta® concept was introduced worldwide in 1999 with the addition of an octagon to the Morse taper section of the abutment and implant.

The symmetrical fit of the octagons of the abutment and the inside of the implant allows synOcta® abutments to be repositioned in the implant. This feature is unique within the Straumann® Dental Implant System and is possible only with the synOcta® Abutments. The capacity for repositioning allows the clinician to take an impression over the implant shoulder without an abutment. The possibility of selecting the abutment with the aid of the Planning Set with the resulting flexibility is one of the factors in the success of the synOcta® prosthetic system. Besides the increased flexibility of the system, the 8° Morse taper connection represents one of the most secure implant-abutment connections in implantology.

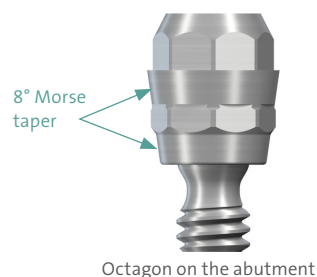

Screw-retained and cement-retained solutions for implants with shoulder diameter of 4.8 mm RN and 6.5 mm WN

With the synOcta® prosthetic system you have a choice between screw-retained or cement-retained crown and bridge restorations for implant shoulders of both Ø 4.8 mm RN (Regular Neck) and Ø 6.5 mm WN (Wide Neck).

RN Implant shoulder Ø 4.8 mm



Standard and Standard Plus Implants RN



Tapered Effect Implants RN

Important: The octa, cone and Solid Abutments can be used with implants with or without the internal octagon. The RN synOcta® Abutments can only be used with implants with shoulder Ø 4.8 mm and implants with the internal octagon.

WN Implant shoulder Ø 6.5 mm

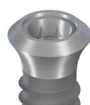

Standard and Standard Plus Implants WN



Tapered Effect Implants WN

Important: The WN Solid Abutments and the WN synOcta® Abutments can only be used with implants with shoulder Ø 6.5 mm.

2 Advantage

Reliable. Simple. Flexible.

The synOcta® prosthetic system offers you the advantages of a reliable, simple and flexible prosthetic solution.

The secret of synOcta®'s success exists in the connection between the abutment and the implant. The precise fit of the abutment octagon in the implant octagon allows the abutment to be repositioned.

Reliable

- The 8° cone of the Morse taper offers an ideal combination between cold welding and reliable vertical positioning.
- The rates of loosening of the Straumann Morse taper are practically going towards 0%.

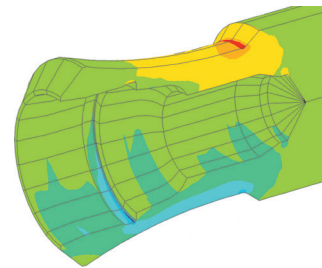

Simple

- Simple impression taking without the abutment

Flexible

- Abutments can be repositioned
- Abutment selection on the model
- Optimal planning options for every indication

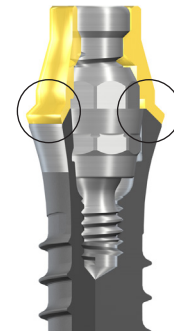

The prosthetic superstructures that are screwed onto the synOcta® Abutments distribute the acting forces onto the 45° shoulder of the implant and thus relieve the Occlusal Screw.

Important: Please note the description of the indication for each implant type. You will find this in the current product catalog, in the brochure *Straumann® Dental Implant System, Basic Information (152.754/en)* and in the instructions for use enclosed with the implants.

RN = Regular Neck

WN = Wide Neck

RN (Regular Neck)
Ø 4.8 mm

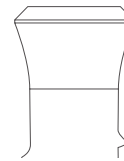

Transfer parts

synOcta®

**Impression Posts
Impression Caps
Implant Analogs
Forming/Fixing Matrices**

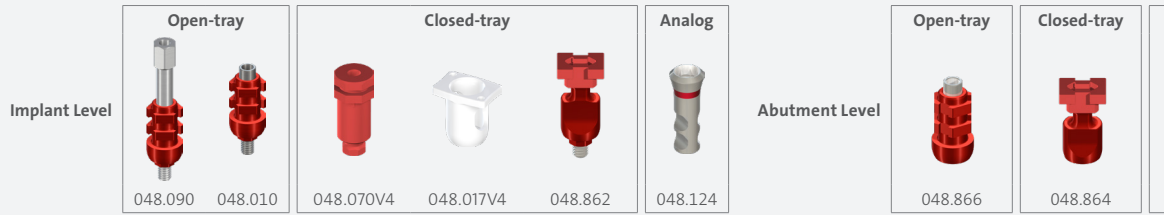

**Digital Impression Posts
Scanbodies and
Repositionable Analogs**



**Temporary Restorations
Protective Caps**



Prosthetic Restoration

Screw-retained

Screw-retained or Cement-retained

**CAD/CAM
Wax-up**

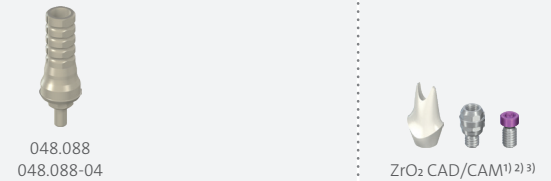

Titanium Abutments



**Gold Copings
Gold Abutments**



Plastic Copings



**Auxiliary Parts
Screws**



-04 Pack of 4
AH Abutment height
H Height
V2 Pack of 2
V4 Pack of 4
WN Wide Neck







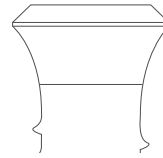



















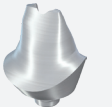





1) Straumann® CARES® Abutments can be ordered via the Straumann® CARES® Visual Software or at www.cares.straumann.com
2) manufactured at the Straumann® CAD/CAM production center
3) also via Straumann® CARES® Scan & Shape Service

• Crown
•• Bridge
••• Bar
Product images are not to scale.

WN
 Ø 6.5 mm









synOcta®

Implant Level				Abutment Level		
<p>Analog</p>  <p>048.108</p>	<p>Open-tray</p>  <p>048.091</p>	<p>Closed-tray</p>  <p>048.095</p>  <p>048.013</p>  <p>048.870</p>	<p>Analog</p>  <p>048.171</p>	<p>Open-tray</p>  <p>048.869</p>	<p>Closed-tray</p>  <p>048.871</p>	<p>Analog</p>  <p>048.872</p>
	 <p>048.172</p>		 <p>048.069</p>		 <p>048.169</p>	
	 <p>•048.717 incl. screw 049.181</p>	 <p>••048.718 incl. screw 049.181</p>		 <p>•048.242 incl. screw 048.356</p>		
Cement-retained	Screw-retained	Screw-retained or Cement-retained	Screw-retained or Cement-retained	Cement-retained	Cement-retained	Cement-retained
 <p>Titanium CAD/CAM^(1) 2) 3) incl. screw 048.356</p>		 <p>048.089 048.089-04</p>		 <p>Titanium CAD/CAM^(1) 2) 3) incl. screw 048.356</p>		
 <p>synOcta® Cementable 048.605 incl. screw</p>	 <p>synOcta® 1.5 048.603</p>			 <p>synOcta® 1.5 Angled 048.608 048.609</p>	 <p>synOcta® Cementable 048.606</p>	
	 <p>synOcta® gold coping •048.639 ••048.638 excl. screw 048.350</p>	 <p>synOcta® gold coping •048.644 ••048.803 incl. screw 048.356</p>				
 <p>••048.662</p>  <p>•048.663</p>	 <p>•048.667 ••048.666 excl. screw 048.350</p>			 <p>048.678</p>  <p>•048.243 ••048.244</p>		
 <p>048.356</p>	 <p>048.350</p>	 <p>048.356</p>		 <p>048.356</p>		













3 synOcta® Abutments – Overview

Application range for abutments for implant shoulders 4.8 mm and 6.5 mm

Implant shoulder-Ø 4.8 mm RN					
RN synOcta® 1.5 Screw-retained	RN synOcta® Cemented	RN synOcta® Angled, 15° and 20°, type A and B		RN synOcta® Transversal (TS)	WN synOcta® Cemented
 Art. No. 048.601	 Art. No. 048.605	 15° Art. No. 048.612	 20° Art. No. 048.617	 Art. No. 048.620	 Art. No. 048.642
Transocclusal screw-retained crowns and bridges.	Cement-retained crowns and bridges. The abutment can be shortened as necessary by a maximum of 2.0 mm.	Cement-retained or screw-retained crowns and bridges. In the case of Angled Abutments, two types are available for each angle (A+B). This allows the angle to be corrected in 16 different alignments (in steps of 22.5°). These abutments are available in a short and a long version.		Transversal screw-retained crowns and bridges. The RN synOcta® TS Abutment has two transversal openings. One screw opening is aligned with the flat wall of the octagon, while a second screw opening is aligned with the apex. This enables the Transversal Screw to be aligned in 16 different directions (in steps of 22.5°).	Transocclusal screw-retained crowns and for the production of a meso structure for cement-retained crowns and bridges. The Gold Abutment is a combination of coping and abutment.

Implant shoulder-Ø 6.5 mm WN			
WN synOcta® 1.5 Screw-retained	WN synOcta® Cemented	WN synOcta® Angled, 15°, type A and B	WN synOcta® Gold Abutment
 Art. No. 048.603	 Art. No. 048.606	 Art. No. 048.608	 Art. No. 048.644
Transocclusal screw-retained crowns and bridges.	Cement-retained crowns and bridges. The abutment can be shortened as necessary by a maximum of 2.0 mm.	Cement-retained crowns and bridges. The WN synOcta® Angled Abutment, 15°, is available in 2 types (A and B). This allows the angle to be corrected in 16 different alignments (in graduations of 22.5°).	Transocclusal screw-retained crowns and for the production of a meso structure for cement-retained crowns and bridges. The Gold Abutment is a combination of coping and abutment.

4 Impression procedure with the synOcta® prosthetic system

Closed-tray		Open-tray				
Screwed		Screwed				
Implant level	RN  048.862	WN  048.870	Implant level	RN  048.090	WN  048.010	WN  048.091
	Abutment level	RN  048.864		WN  048.871	Abutment level	RN  048.866
Snap-on						
Implant level	RN  048.070V4	WN  048.017V4	Implant level	WN  048.095	WN  048.013	
	Analog					
Implant level	RN  048.124	WN  048.171	Implant level	RN  048.108	WN  048.872	
	Abutment level	RN  048.108		WN  048.872	Abutment level	





There are three options available for taking an impression on implant shoulder- \varnothing 4.8 mm RN and implant shoulder- \varnothing 6.5 mm WN:

- the closed-tray technique "screwed"
- the closed-tray technique "snap-on"
- the open-tray technique "screwed"

The closed-tray "screwed" option can be regarded as the standard version.

Extra care should be taken to identify implant and abutment level impression positions in case of mixed level impressions in the same patient.

4.a Closed-tray impression procedure “Screwed”

Implant shoulder Ø 4.8 mm RN		Implant shoulder Ø 6.5 mm WN	
			
Art. No. 048.862	Art. No. 048.124	Art. No. 048.870	Art. No. 048.171

The impression-taking procedures for implant shoulder Ø 4.8 mm RN and implant shoulder Ø 6.5 mm WN are identical.

All parts of the transfer system are supplied non-sterile. The parts can be disinfected as required using standard commercial disinfectants that are suitable for plastic products. Follow the manufacturer's instructions.

Caution: The plastic components are for single use only. They must not be sterilized. In order to prevent damage to the plastic components (loss of elasticity or embrittlement), they must be protected from strong light and heat.

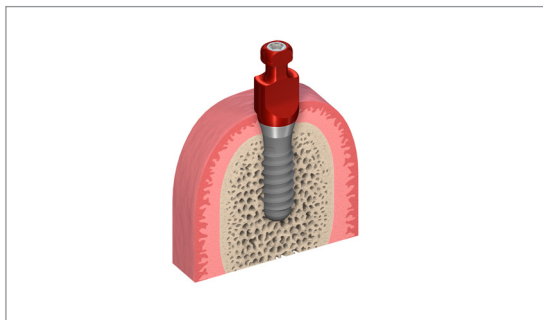

Step 1 – Positioning the Impression Post

- Ensure sufficient access to the implant site in order to avoid pinching in the gingival tissue.
- Clean the internal configuration of the implant thoroughly from blood, tissue, etc. prior to the impression procedure.
- Place the impression post accurately into the implant and tighten the guide screw hand-tight (using the SCS screwdriver)

Note: Ensure that the lateral planar areas of the post are facing mesial and distal.



- Place the polymer impression cap on top of the fixed impression post. Ensure that the color of the cap corresponds to the color of the positioning screw in the post and that the arrows are aligned with the oral-vestibular direction.
- Push the impression cap in apical direction until it clicks. The impression cap is now firmly seated on the impression post.



Step 2 – Impression taking

- Take the impression using an elastomeric impression material (polyvinyl siloxane or polyether rubber).







Note: Due to its low tensile strength, hydrocolloid is not suitable for this application.



- Once the material is cured, carefully remove the tray. The impression cap remains in the impression material and therefore is automatically pulled off from the impression post with the removal of the tray.
- Unscrew and remove the impression post and send it together with the impression tray to the dental technician.



4.b Closed-tray impression procedure “Snap-on”

Implant shoulder \varnothing 4.8 mm RN			Implant shoulder \varnothing 6.5 mm WN		
					
Art. No. 048.070V4	Art. No. 048.017V4	Art. No. 048.124	Art. No. 048.095	Art. No. 048.013	Art. No. 048.171

The impression-taking procedures for implant shoulder \varnothing 4.8 mm RN and implant shoulder \varnothing 6.5 mm WN are identical.

All parts of the transfer system are supplied non-sterile. The parts can be disinfected as required using standard commercial disinfectants that are suitable for plastic products. Follow the manufacturer's instructions.

Caution: The plastic components are for single use only. They must not be sterilized. In order to prevent damage to the plastic components (loss of elasticity or embrittlement), they must be protected from strong light and heat.

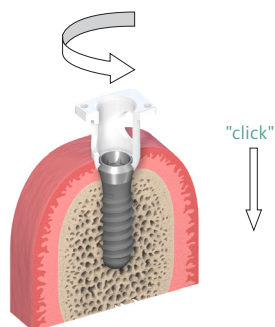

Step 1 – Positioning of the Impression Cap

Both the implant shoulder and the internal configuration must be cleaned (of blood and tissue) prior to the impression procedure. Push the RN Impression Cap (048.017V4) onto the implant shoulder until it clicks into place. Gently turn the Impression Cap to ensure that it is in the correct position. When the cap is in the correct position, it can be rotated on the implant.

Important: The shoulder and the margin of the Impression Cap must not be damaged to ensure accuracy of the impression procedure.

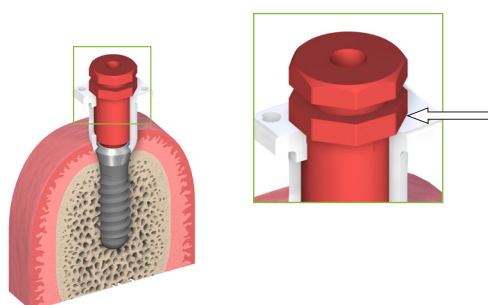

Step 2 – Insertion of the positioning cylinder

The octagon of the RN synOcta® Positioning Cylinder must be properly aligned with the octagon in the implant and pushed into the Impression Cap as far as it will go.







Step 3 – Impression taking

The impression is taken using an elastomeric impression material (polyvinyl siloxane or polyether rubber).

Important: Due to its low tensile strength, hydrocolloid is not suitable for this application.

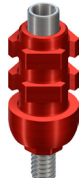

4.c Open-tray impression procedure “Screwed”

Implant shoulder \varnothing 4.8 mm RN		Implant shoulder \varnothing 6.5 mm WN		
				
Art. No. 048.010	Art. No. 048.090	Art. No. 048.124	Art. No. 048.091	Art. No. 048.171

The open-tray impression-taking procedure is identical for implant shoulder \varnothing 4.8 mm RN and implant shoulder \varnothing 6.5 mm WN.

For this impression procedure a custom-made tray with perforations is needed.

Important: Only the integral screw must be used. The margin and the octagon must not be damaged to ensure accuracy of the transfer procedure. For this reason, the Impression Caps are intended for single use only.



Step 1 – Positioning of the Impression Cap

Both the implant shoulder and the internal configuration must be cleaned (of blood and tissue) prior to the impression procedure. Place the RN synOcta® Impression Cap (048.010) onto the implant shoulder and tightened it with the Integral Guide Screw. It is important to accurately position the octagon in the implant before the screw is tightened.

Option: If space is adequate, the impression can also be taken with the open-tray RN synOcta® Impression Cap with built-in handle (048.090).



Step 2 – Impression taking

The custom-made tray (light-cured resin) contains perforations for the Guide Screws.

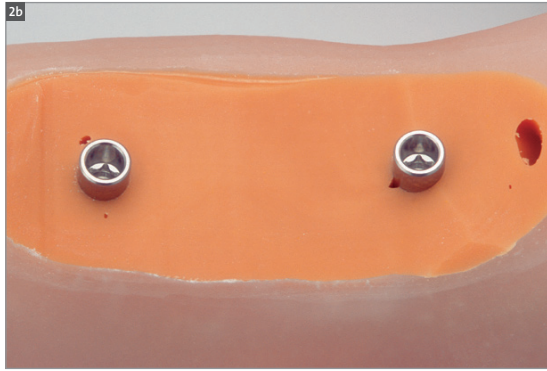

The impression is taken using an elastomeric impression material (polyvinyl siloxane or polyether rubber).

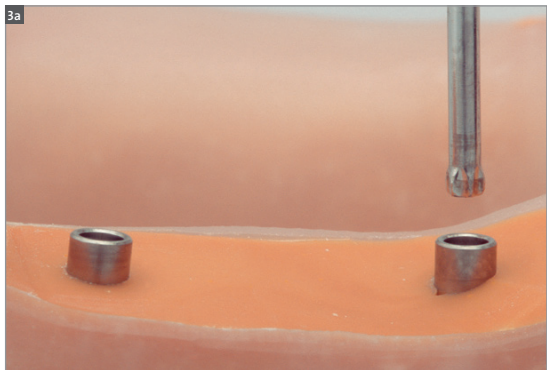

Step 3 – Once cured, the Guide Screw is loosened and the impression is removed.

Important: Due to its low tensile strength, hydrocolloid is not suitable for this application.

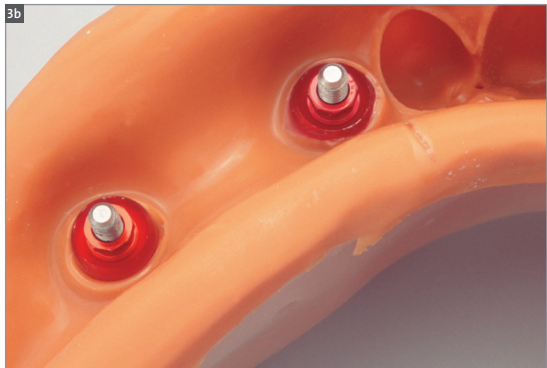

5 Bite registration

For implant shoulders: \varnothing 4.8 mm RN and \varnothing 6.5 mm WN



To simplify bite registration after taking an impression, plastic Bite Registration Aids are available in heights of 8.0 mm (048.940V4) and 12.0 mm (048.941V4). The diameter is 5.0 mm. For repositioning on the master cast, the Bite Registration Aids have a flat side laterally.



Step 1 – The components are each fitted with a snap-in mechanism that holds them in the internal configuration of the implant.

Important: Protect against aspiration when using these components (e.g. use of a throat pack is recommended).



Step 2 – To ensure the repositioning from the mouth to the master cast, the occlusal area and the lateral flat side of the Bite Registration Aids must be adequately surrounded by bite registration material.



Step 3 – To transfer the bite, the Bite Registration Aids are then put in the analogs on the master cast, the bite wax model is fixed, and the maxilla and mandible casts are mounted on the articulator.

Note: Bite Registration Aids must be shaped outside of the mouth. If they need to be shortened occlusally due to lack of space, ensure that the lateral flat side is not ground off.



6 Temporary restorations

Until the definitive superstructure has been made, the implants can be restored with temporary crowns and bridges. There are two possible options:

6.1 Restoration with the RN/WN synOcta® Temporary Meso Abutment

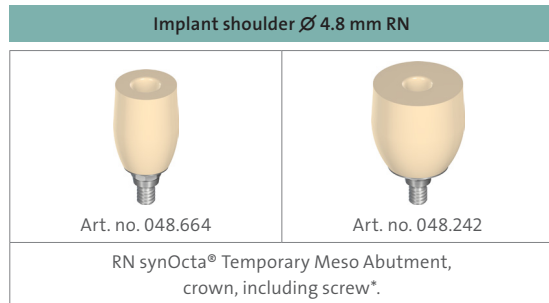

Temporary restoration with the RN synOcta® Temporary Meso Abutment is suitable especially for soft tissue conditioning in the anterior esthetic region. Resin veneering on the Temporary Meso Abutment can be done easily by the dentist during surgery. The RN synOcta® Temporary Meso Abutment consists of a polymer abutment that is reinforced with a titanium inlay that covers the implant shoulder. It is placed directly on the implant or analog and is fixed with the corresponding screw.

*Screw available separately under Art. No. 048.356.

Chairside fabrication

The Temporary Meso Abutment is customized individually. To make it easy to loosen the Basal Screw, the occlusal opening is sealed with cotton wool or wax prior to veneering.

The temporary denture is fabricated as follows, using standard techniques:

Direct veneering using the vacuum-formed foil technique



As in conventional fabrication of a temporary, strip crowns can optionally be filled with resin and attached. After biting down, the excess is removed; and after curing the crown is removed, polished and the occlusal screw channel is opened again.

Temporary cementing of a pre-fabricated crown



Fabrication of a resin crown over the modified Temporary Abutment using standard technique.

When inserting the Temporary Meso Abutment, we recommend a tightening torque of 15 to 35 Ncm.

Important: the RN synOcta® Temporary Meso Abutment must not remain in situ for more than 6 months, and the restoration must always be under-occluded in order to reduce lateral forces.

Restorations made from VITA CAD-Temp® can be pre-polished with a suitable silicone polisher and a small goat hair brush. Standard acrylic polishing agents that are also suitable for intraoral use are used for high luster polishing. Avoid creating excessive heat.

Important: Careful polishing is absolutely necessary to achieve a natural looking result and to avoid plaque accumulation as well as related negative effects on the shade. Use a Polishing Aid or Implant Analog to protect the implant configuration while polishing the temporary restoration.



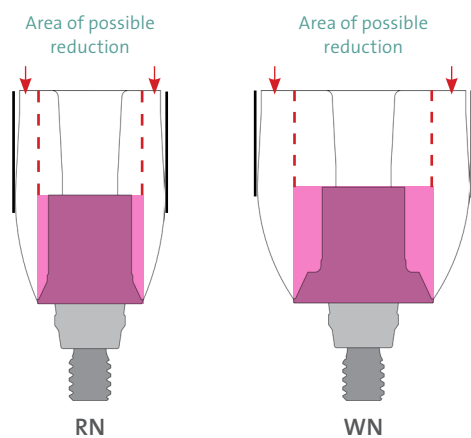

Modification of abutments – How far to reduce the dimensions



Red line indicates the area of maximum reduction

The Temporary Abutment height can be shortened with standard tools and techniques, but should not be reduced beyond the metal core. The **width must not be reduced** by more than 1 mm at the thickest part (NNC, NC) or further than the metal margin (RN, WN, RC).

6.2 Restoration with the synOcta® Posts for temporary restorations (for RN and WN)

Implant shoulder Ø 4.8 mm RN		Implant shoulder Ø 6.5 mm WN	
			
Art. No. 048.715 •	Art. No. 048.716 ••	Art. No. 048.717 •	Art. No. 048.718 ••

• crown
•• bridge

Fabrication of the temporary restoration on implant shoulder Ø 4.8 mm RN and implant shoulder Ø 6.5 mm WN is identical.

This temporary restoration can be fabricated optionally by the dentist directly during surgery or by the dental technician in the laboratory. The synOcta® Posts are made of titanium and are screwed directly to the implant or analog with the integral screw.



Chairside fabrication:

The posts are shortened below the occlusion level and the occlusal openings are sealed with wax or cotton wool. To avoid the titanium showing through the resin, coating the posts with opaquer prior to veneering is recommended.

The temporary restoration is fabricated with the usual standard techniques. For instance vacuum-formed foil or, as in conventional fabrication of temporaries, with strip crowns filled with resin which are attached to the post. After biting down, the excess is removed and after curing, the crown/bridge is removed, polished and the occlusal screw channels are opened again.



Fabrication in the laboratory:

The posts can be veneered by grinding ready-made acrylic teeth or by direct modelling with resin. This option is suitable especially if there is a silicone index of the wax-up. The titanium posts are silanised to ensure better adhesion of the resin. To avoid the titanium showing through the resin, coating the posts with opaquer prior to veneering is recommended. The temporary is made with veneering resin. Integration of a metal reinforcement between the posts is recommended for bridge constructions.



Important: the prefabricated titanium posts cannot be used for the casting technique.

When inserting the posts, we recommend a tightening torque of between 15 and 35 Ncm.

Important: the synOcta® Posts must not remain in situ for more than 6 months and the restoration must always be under-occluded in order to reduce lateral forces.

7 Fabricating the master cast

Analogs for:

Implant shoulder Ø 4.8 mm RN	Implant shoulder Ø 6.5 mm WN
 <p>Art. No. 048.124</p>	 <p>Art. No. 048.171</p>

The fabrication of the master cast for implant shoulder Ø 4.8 mm RN and implant shoulder Ø 6.5 mm WN is identical.

Important: To avoid inaccuracies when taking the impression, the analog in both versions must be connected exactly with the octagon of the impression components (before snapping it on or screwing it in).

Color coding	
RN synOcta® impression components on implant shoulder Ø 4.8 mm	red
WN synOcta® impression components on implant shoulder Ø 6.5 mm	white

Closed-tray technique (screwed):

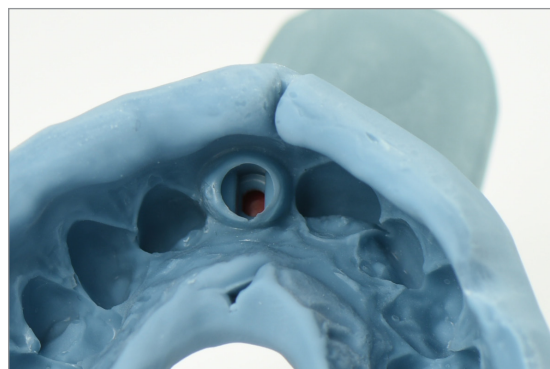

Mount the impression post on the analog using the guide screw. To avoid inaccuracies when connecting, the analog must be positioned exactly in line with the grooves of the impression post before screwing it in.

Note: Ensure that the color code of the guide screw corresponds to the color code of the analog and that the color code of the analog corresponds to the color code of the polymer cap in the impression material.

- Reposition the impression post in the tray.
- Smoothly push the impression post until you feel the tactile response of engagement. It is now firmly seated on the impression cap in the impression tray.

Closed-tray technique (snapped):



In the laboratory the RN synOcta® Analog (048.124) is repositioned in the impression. The shoulder must click audibly into place. The red RN synOcta® Positioning Cylinder indicates to the dental technician that the RN synOcta® Analog with the red line must be used.





Open-tray technique (screwed):

The RN synOcta® Analog is fixed in the impression using the Integral Guide Screw. The red RN synOcta® Impression Cap indicates to the dental technician that the RN synOcta® Analog with the red line must be used.

Important: When tightening the screw, grasp the retentive section of the analog in order to prevent the Impression Cap from rotating. This is especially important if the cap has been shortened.

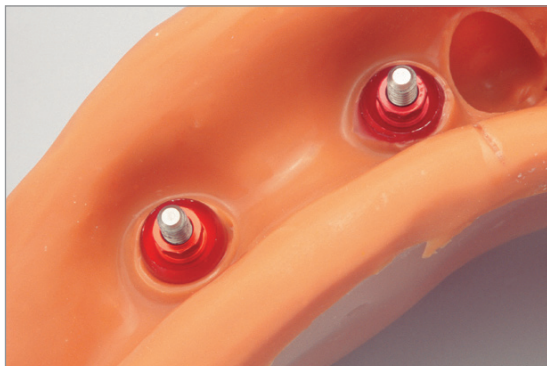

Fabrication of working model

Tip: A gingival mask should always be used to ensure that the emergence profile of the crown is contoured optimally. This is essential for restorations in esthetically demanding regions and with subgingival crown margins.

Conventional fabrication of the working model using special hard plaster type 4

8 Case planning with the Prosthetic Planning Kit



Intended use

- Intraoral and extraoral planning of prosthetic restoration

Characteristics

Simple

- Color-coded and easily identifiable Plan Abutments
- Comprehensive Plan Set containing all Plan Abutments clearly arranged

Reliable

- Proper seating of Plan Abutments verified through the clear-cut response from the prosthetic connection
- Plan Abutments made of sterilizable polymer material

Note: After intraoral use clean and sterilize Plan Abutments with moist heat. Do not sterilize the cassette or its inserts. Replace non-functional Plan Abutments.











Soft Tissue Level Plan Set/Plan Abutment selection

The Straumann® Soft Tissue Level Plan Set (048.904) allows for optimal planning of the restoration in the mouth and on the model. This gives the dentist and the dental technician greatest flexibility in cooperative planning and minimizes the number of abutments that need to be stocked.

This kit contains plastic abutments for crown and bridge restorations that can be placed on the analogs in order to check the height, axial alignment and screw axis.

This also makes it easy to determine which of the Angled Abutments (type A or B) offers the best solution.





RN synOcta® Plan Abutments for implant shoulder Ø 4.8 mm

					
Art. No. 048.929	Art. No. 048.921	Art. No. 048.916	Art. No. 048.917	Art. No. 048.918	Art. No. 048.919
					
Art. No. 048.922	Art. No. 048.923	Art. No. 048.924	Art. No. 048.925	Art. No. 048.930	

Color coding

RN synOcta® Plan Abutments for implant shoulder Ø 4.8 mm	red
--	-----

WN synOcta® Plan Abutments for implant shoulder Ø 6.5 mm

			
Art. No. 048.931	Art. No. 048.933	Art. No. 048.934	Art. No. 048.932

Color coding

WN synOcta® Plan Abutments for implant shoulder Ø 6.5 mm	grey
--	------



A) Selecting the right abutment

Open the Plan Set. Use a pair of tweezers or the SCS Screwdriver to transfer the Plan Abutments from and to the mouth or model.

If using intraorally, take care to prevent aspiration of the parts.

Place the Plan Abutment on the implant (intraoral use) or Implant Analog (extraoral use). This will help in checking dimensions (rings on Plan Abutments indicate gingiva height), axial alignment and screw axis of the potential restoration.



B) Ordering the stock abutment

Once the best-fitting Plan Abutment is determined, the corresponding stock abutment can be ordered using the allocation chart on the Plan Set inlay card.

Cleaning and sterilizing Plan Abutments



Clean the Plan Abutments thoroughly with water or ethanol after intraoral use.

After cleaning, sterilize Plan Abutments with moist heat (autoclave) for 18 minutes at 134 °C (273 °F). Refer to the manufacturer's specifications for the heat-sterilization device.

Note: Do not sterilize Plan Abutments more than 20 times. Do not gamma-sterilize Plan Abutments. Do not sterilize the cassette or its components.

9.a synOcta® 1.5 Screw-retained

Abutments for transocclusal screw-retained crowns and bridges

Implant shoulder Ø 4.8 mm RN	Implant shoulder Ø 6.5 mm WN
 <p>Art. No. 048.601</p>	 <p>Art. No. 048.603</p>

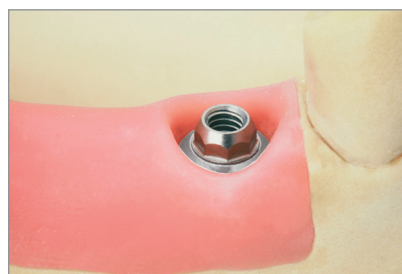
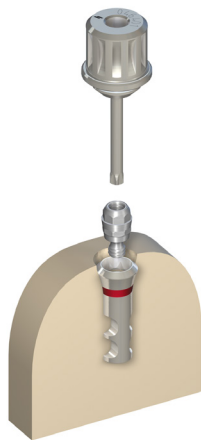

A) Fabrication of the superstructure

Inserting of the abutment

The original abutment is put on the analog and aligned in the octagon.

Important: The abutment must be properly positioned in the octagon before the screw is tightened.

The screw is tightened by hand using the SCS Screwdriver.

B) Process of the copings



Version 1: synOcta® Gold Copings for the cast-on technique

The Gold Copings are made of a non-oxidizing high-fusing alloy (Ceramicor®: Au 60 %, Pt 19 %, Pd 20 %, Ir 1%; melting range 1400–1490 °C, 2552–2714 °F). With these copings, the Modeling Aid (burn-out plastic) is already in place. The Modeling Aid can be shortened if necessary.

Tip: Never cast without the Modeling Aid. Otherwise the metal-ceramic alloy will not flow at all or will be too thin at the upper edge of the coping (screw seating on the coping), leading to a risk of cracks appearing in the ceramic because of different heat expansion coefficients. The Modeling Aid also ensures that the end of the screw channel is clean and sharp-edged.



Step 1 – Position the selected Gold Coping or Plastic Coping, then secure with an SCS Occlusal Screw or SCS Guide Screw. Depending on the individual circumstances, the Modeling Aid, Plastic Coping and/or the Guide Screw may need to be shortened to the height of the occlusal plane.



Step 2 – Wax up the framework in the conventional manner for veneers (plastic/porcelain). Use the silicone key of the wax-up to check the framework shape.

The modeling is carried out on a scaled-down tooth shape.

The crowns must be premolarized in size to reduce the risk of nonaxial loading and prevent plaque accumulation due to overcontouring.



Step 3 – When waxing up the framework, ensure that those areas of the prefabricated Gold Copings that are to be veneered with porcelain are coated with wax (at least 0.7 mm). As the Gold Coping consists of a non-oxidizing alloy, the porcelain cannot be bonded directly onto it (no oxidation for bonding).

Important: Do not cover the delicate margin of the copings with wax. The use of investment material for rapid heating methods (speed investment methods) is not recommended. Do not use wetting agents.

Tip: Before investment, it is recommended that the delicate margin is cleaned with a cotton bud (dipped in alcohol) as even minimal wax residue here can lead to overflow of the cast-on alloy onto the edge or into the interior of the coping.



Art. No. 048.227
RN synOcta® Plastic Coping
without internal octagon for
bridge, for use with 048.601



Art. No. 048.229
RN synOcta® Plastic Coping
with internal octagon for
crown, for use with 048.601



Art. No. 048.666
WN synOcta® Plastic Coping
without internal octagon for
bridge, for 048.603



Art. No. 048.667
WN synOcta® Plastic Coping
with internal octagon for
crown, for 048.603

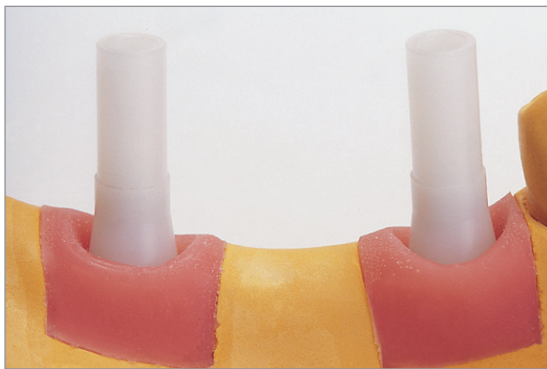

Version 2: synOcta® Plastic Copings for the burn-out technique

The Plastic Copings are made of a fully burn-out plastic and can be shortened if required.

Note: A cast component can never achieve the perfection of a prefabricated component, which is first rolled and drawn, then machined to provide excellent mechanical strength.

Important: When using Plastic Copings, the occlusal or Guide Screw should be tightened gently. When modeling on Plastic Copings, the screw seating and the 45° shoulder may be deformed if the screw on the analog is screwed too tightly since plastic is elastic.

Reamer for version 2



The following items are required:

- 1. synOcta® Guide Pin, 046.241, 2. Finishing Instrument for 45° shoulder, 046.243, 3. Handle, 046.240

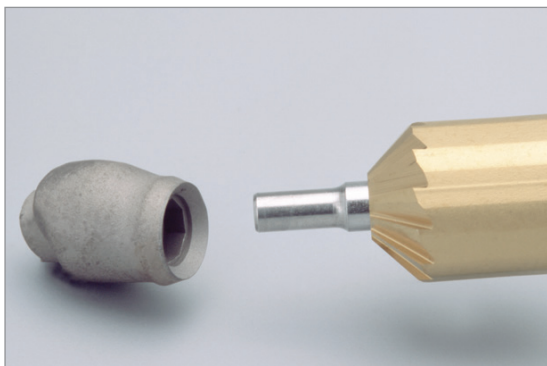

If there are small casting beads on the 45° shoulder of the cast Plastic Coping, the shoulder area can be smoothed using the Finishing Instrument. The synOcta® Guide Pin is inserted in the Handle, the Finishing Instrument is put over the Guide Pin and the Guide Pin is then positioned carefully in the cast coping. The 45° shoulder of the coping is smoothed by rotating the Finishing Instrument slowly and evenly.

Important: The Finishing Instrument has no stop. Abrade only as much as necessary to remove the casting beads. Working under a stereo microscope is recommended. Serious casting defects and extreme unevenness cannot be corrected with the Finishing Instrument. In these cases, the procedure must be repeated.



Art. No. 048.571
RN synOcta® Meso Milling
Cylinder, with internal
octagon, crown edge
Ø 8.0 mm, for 048.601

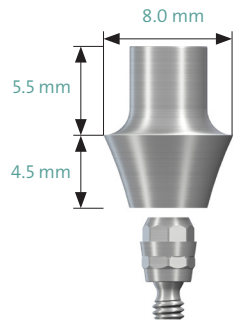

RN synOcta® 1.5
Art. No. 048.601

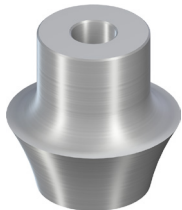

Art. No. 048.573
WN synOcta® Meso Milling
Cylinder, with internal
octagon, crown edge
Ø 10.0 mm, for 048.603

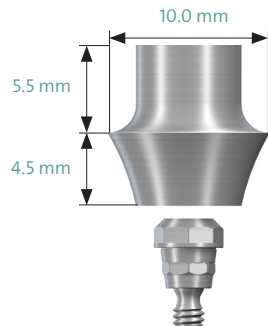

WN synOcta® 1.5
Art. No. 048.603

Version 3: synOcta® Meso Milling Cylinder

The prefabricated synOcta® Meso Milling Cylinders are made of titanium and were developed for cement-retained crown restorations on implants that are placed more than 3.0 mm subgingival.

In the cervical area, the cylinders exhibit a height of 4.5 mm and a diameter of 8.0 mm for RN respectively 10.0 mm for WN and can be customized to provide an optimal emergence profile (anatomical neck shape). The cylinders feature an internal octagon to prevent them from rotating.

Note: synOcta® titanium Meso Milling Cylinders are not suitable for direct ceramic veneering with titanium ceramics.

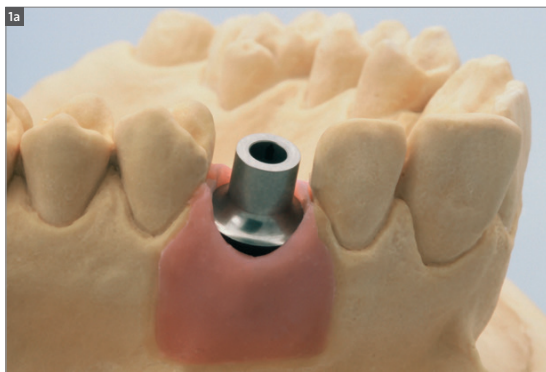

Step 1 – The RN synOcta® Meso Milling Cylinder consists of titanium and can be modified as needed. It has an internal octagon as an anti-rotation safeguard, and is used by the dental technician on the working cast.

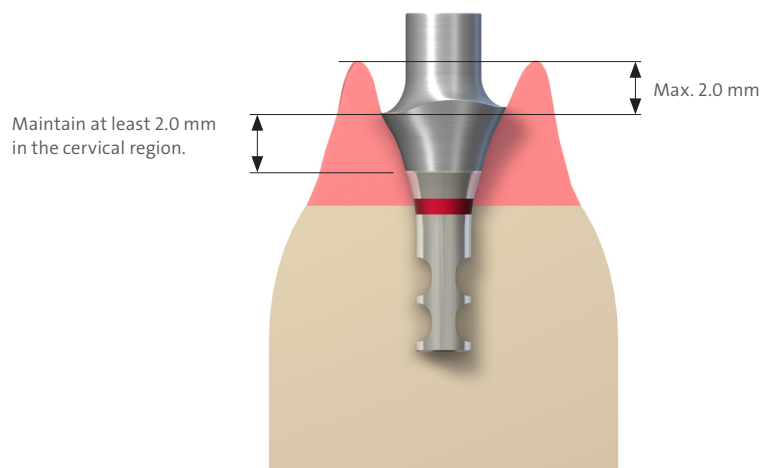

To maintain proper stability of the Meso Milling Cylinder on the abutment, a minimum height of 2.0 mm must be maintained occlusally in the cervical region.

For reasons of hygiene, the cement margin must lie no deeper than 2.0 mm below the gingiva.



Step 2 – The superstructure is fabricated on the modified Meso Milling Cylinder using the usual modeling, casting, and veneering methods.

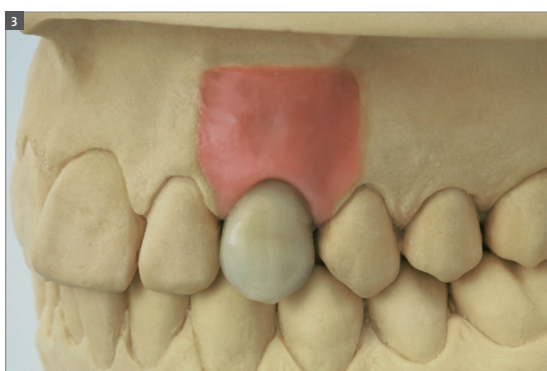

Step 3 – The synOcta® Meso Milling Cylinder is screwed (utilizing an SCS Occlusal Screw, 048.350V4) onto the synOcta® 1.5 Abutment and tightened with a torque of 15 Ncm.



C) Fitting the final restoration

The restoration is delivered to the dentist with the original abutment on the master cast.

Remove the Healing Cap or temporary restoration. Thoroughly clean and dry the interior of the implant.

Remove the superstructure from the implant and the abutment from the analog.

Position the cleaned synOcta® 1.5 Abutment (RN and WN) in the internal octagon **without** the use of cement. Then tighten the abutment screw with the SCS Screwdriver along with the Ratchet (046.119) and Torque Control Device (046.049).

A tightening torque of **35 Ncm** when inserting the abutments is recommended.

Important: The abutment must be properly positioned in the octagon before the screw is tightened.

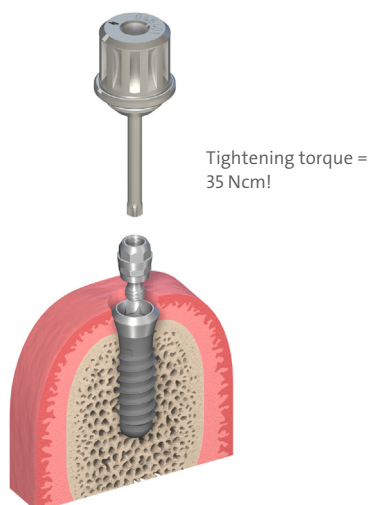



Tighten the superstructure on the synOcta® 1.5 Abutment with a torque of 15 Ncm. The following options are available for securing the superstructure:

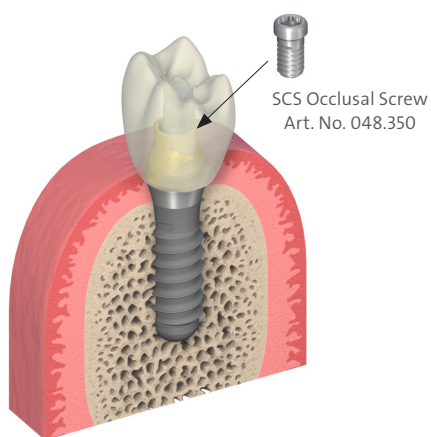

Version 1: Securing with the SCS Occlusal Screw:

With this option, cover the screw heads with a little wax or gutta-percha and then seal the transocclusal screw channels (e.g. with composite).

Tightening torque = 15 Ncm!

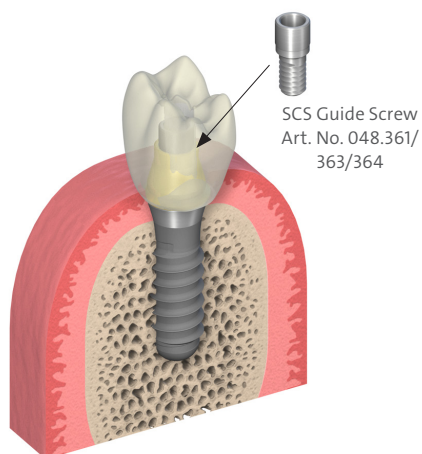

Version 2: Securing with the SCS Guide Screw:

With this option, shorten the SCS Guide Screw intra-orally to the occlusal plane.

Tightening torque = 15 Ncm!

9.b synOcta® Cemented

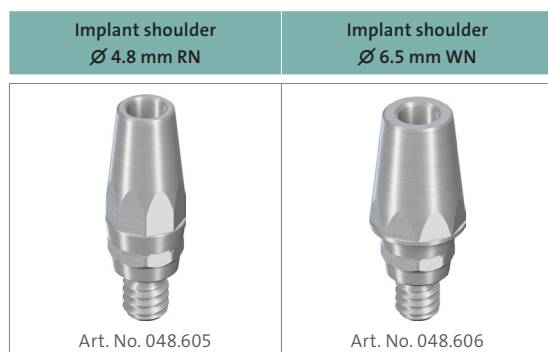

Abutments for cement-retained crowns and bridges

In situations where a screw-retained solution is contraindicated, the dental technician can fabricate a cement-retained superstructure directly with this abutment without further impression-taking by the dentist. Cement-retained bridge constructions in combination with implant shoulders of Ø 4.8 mm RN and Ø 6.5 mm WN are also possible. The abutment can be shortened on the master cast by a maximum of 2.0 mm.

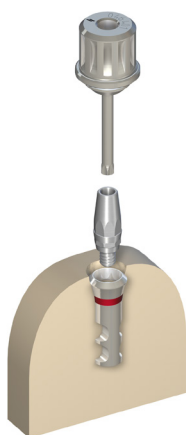

Conventional casting and pressing workflow

A) Fabrication of the superstructure

Insert the abutment in the octagon of the synOcta® Analog using an SCS Screwdriver.

Important: The abutment must be properly positioned in the octagon before the screw is tightened.

The screw is tightened by hand using the SCS Screwdriver





B) Process of the copings

Step 1 – Where occlusal space is limited, the abutment can be shortened by a maximum of 2.0 mm.

Important: The abutment must not be ground laterally but only shortened occlusally to maintain proper stability.



Step 2 – To facilitate the working procedure, prefabricated synOcta® Plastic Copings for 048.605 are available to the dental technician. The copings are made from completely burn-out plastic.

The Plastic Copings are equipped with a snap-on mechanism, which makes them easier to fix onto the synOcta® Analog. The snap-on mechanism must be removed after casting.



Step 3 – The Plastic Copings can also be shortened and are adjusted to the height of the shortened abutment.

The occlusal opening is sealed temporarily with wax or plastic. Waxing up then takes place directly over the Plastic Coping.



Art. No. 048.662
RN synOcta® Plastic Coping
without internal octagon for
bridge, for use with 048.605



Art. No. 048.663
RN synOcta® Plastic Coping
with internal octagon for
crown, for use with 048.605



Art. No. 048.243
WN synOcta® Plastic Coping
with internal octagon for
crown, for use with 048.606



Art. No. 048.244
WN synOcta® Plastic Coping
without internal octagon for
bridge, for use with 048.606



Step 4 – Invest the framework (see pages 62–63). The investment material must be matched to the casting alloy used (follow the manufacturer’s directions and recommendations).

Important: Burn-out plastics are characterized by the fact that they swell up when they are burned out. For this reason it is important that the outside of the Plastic Coping is completely covered with wax. The wax burns off and therefore creates sufficient space in the mold for expansion when burned out in the oven. There must be a wax layer of at least 0.3 mm in the marginal region (do not wax above the delicate margin). If there is insufficient waxing in the marginal region of the coping, there is a risk that the frustum will break in the interior of the invested coping, due to the effects of the expansion of the plastic in the mold.



The following items are required:

- 1. synOcta® Guide Pin, 046.246 for RN respectively synOcta® Guide Pin, 046.247 for WN,
- 2. Finishing Instrument for 45°, shoulder, 046.243,
- 3. Handle, 046.240

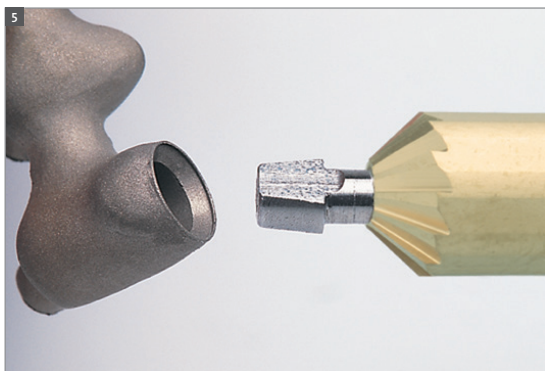

Reamer

Step 5 – The snap-on mechanism can be removed under a microscope using the Finishing Instrument or polishing rubber.

Important: The snap-on mechanism must be removed completely after casting. Otherwise it will not be possible to position the construction exactly on the analogs and implants.

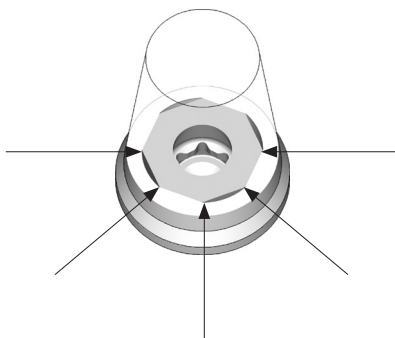

Tip: When trimming the cast coping, do not grind into the corners in the interior, as this leads to rotatory movements of the coping on the abutment.

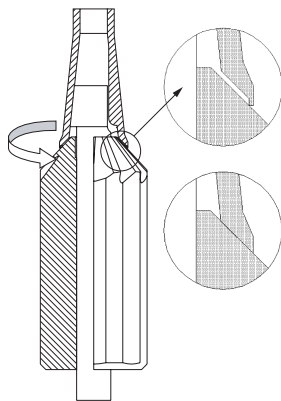

Important: The Finishing Instrument has no stop. Abrade only as much as necessary to remove the casting beads. Working under a stereo microscope is recommended.



Step 6 – The construction can now be veneered in the conventional way. The veneering materials must be matched to the alloy used (follow the manufacturer's directions and recommendations).



Art. No. 048.059V4,
for 048.605, RN



Art. No. 048.054V4,
for 048.606, WN

C) Transfer Aids

To ensure correct transfer of the position of the RN synOcta® Abutment from the master cast to the patient, an individual index can be fabricated on the cast using the Transfer Aid (048.059V4) and plastic. Simply place the Transfer Aid on the abutment situated in the cast. In the case of single crowns, the index is secured with support from the adjacent teeth, and in the case of bridges the abutments are splinted to one another.



Important: The occlusal screw opening must not be covered with plastic. Ensure that no plastic gets into the interior of the abutment, otherwise it will not be possible to loosen the integral abutment screw.



D) Fitting the final restoration

The restoration is delivered to the dentist with the original abutments on the master cast.

Remove the Healing Cap or temporary restoration. Thoroughly clean and dry the interior of the implants.

Remove the screws of the abutments from the master cast using an SCS Screwdriver and place the Transfer Aid in the patient's mouth. Use the SCS Screwdriver for the transfer.



Important: Properly position the cleaned RN synOcta® Abutments in the internal octagon without the use of cement.

Tighten the abutment screws with the SCS Screwdriver along with the Ratchet (046.119) and Torque Control Device (046.049).

Important: The abutment must first be properly positioned in the octagon of the implant before the screw is tightened.

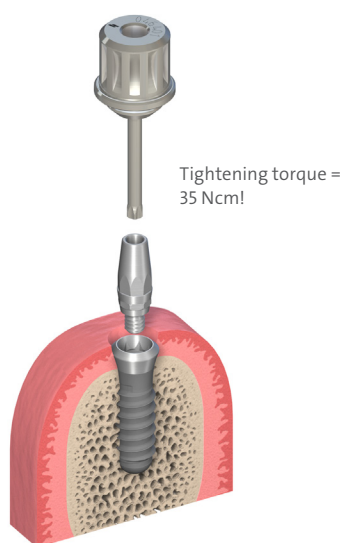

A tightening torque of **35 Ncm** is recommended for inserting the abutments.

Digital workflow (CAD/CAM)

Step 1 – Scanning and designing with a scanbody

Import the Straumann® Cementable Abutment Implant Kit into the design software according to the software manufacturer's instructions.



A) Assembling

Check proper fit of the scanbody in the analog and hand-tighten the self-retaining screw (maximum 15 Ncm). Only use the Straumann® SCS Screwdriver to fix the post in the analog. Check again proper fit and for any rotational or vertical looseness. If a single-tooth restoration is planned, orient the angled surface of the scanbody vestibular (not adjacent to the approximal tooth). Avoid any contact of the scanbody to the proximal teeth.

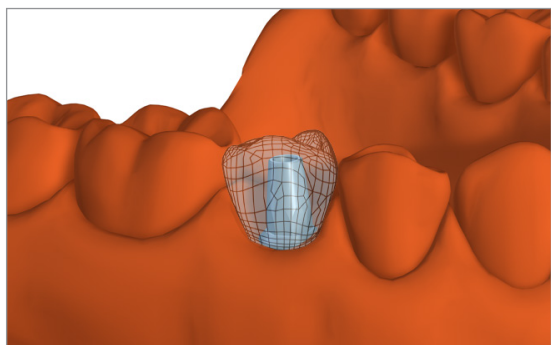

B) Scanning

Follow the Straumann® CARES® Visual CAD software provider's instructions on how to scan and recognize the scanbody.

Note: Bridges exceeding 8° angulation between implants may not fit onto the abutments.

C) Modelling

Model the framework or the full-contour restoration following the software provider's instructions.

Step 2 – Milling



Option A – Send design to Straumann milling center

Transfer your design data to Straumann via CARES® X-Stream™ and receive all prosthetic components in one delivery (e.g. abutment and its relevant superstructure).

Option B – Milling

Mill the prosthetic restoration according to the proper settings per material and following the instructions of your CAD software and milling equipment provider.

Step 3 – Finalization of the prosthetic restoration in the dental laboratory



Finalization of the prosthetic restoration

Use standard procedure to finalize the prosthetic restoration.

Send finalized restoration and abutment to the dentist for final fitting and bonding in the patient's mouth.

Note:

- The superstructure must be completely finalized before the bonding step.
- For the fitting of bridges, some adjustments of the margin of the crown over the TL abutment may be required. Make a fit-check and necessary initial adjustments on a stone model.
- Having a thicker margin around the abutment, allows for more fitting compensation.

Step 4 – Final insertion

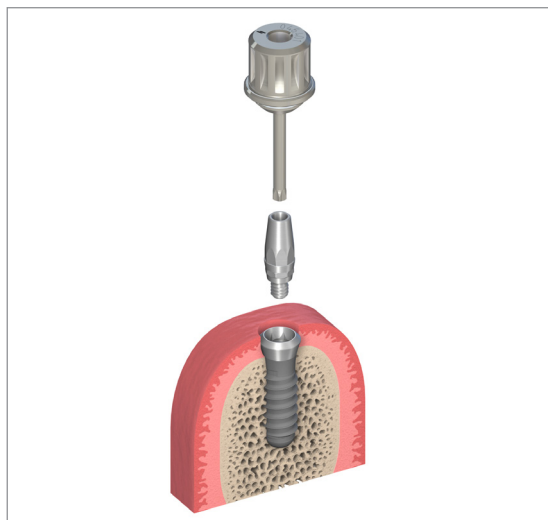

A) Fitting the final crown restoration

The restoration is delivered to the dentist with the original abutment. Place the abutment in the patient's mouth.

B) Bonding

The abutment screw is tightened with the SCS Screwdriver along with the Ratchet (046.119) and Torque Control Device (046.049).

A tightening torque of 35 Ncm is recommended for inserting the abutments.

Cement the superstructure to the abutment.

Remove excess cement.



Note:

- Due to the symmetrical nature of the Cementable Abutments, confirm the orientation of the crown according to the actual patient anatomy prior to bonding.
- The abutment must be properly positioned in the implant before the screw is tightened.
- The occlusal opening must be sealed with cotton and sealing compound (i.e. gutta-percha).
- For restorations on TL abutments, ensure that the cement covers the implant top surface as well as the abutment so that the restoration is cemented securely.

9.c synOcta® Angled for RN



15° and 20° Angled Abutments for screw-retained and cement-retained crowns and bridges

RN Angled Abutments allow prosthetic restorations to be performed while equalizing the implant axis at the same time. The angles of 15° and 20° mean that the angle of insertion required for each situation can be determined and the necessary axis correction made. The Angled Abutment allows removable (transocclusal screw-retained) and cement-retained crowns and bridges to be fabricated.

Important: RN Angled Abutments must not be used with 15° angled hollow cylinder implants.

Due to their design, Angled Abutments must not be trimmed or individually modified.



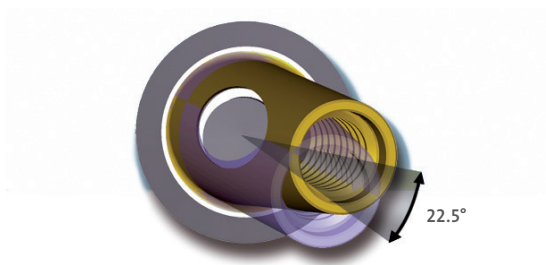

The RN synOcta® Angled Abutments are available in a short version (Art. No. 048.612/613/617/618) and a long version (Art. No. 048.610/611/615/616). The handling of both versions is identical. The difference in height is 1.0 mm.



Selecting the correct abutment

Two types of RN synOcta® Angled Abutments are available for each angle. This enables the axis to be corrected in 16 different alignments (in 22.5° graduations).

The use of the Prosthetic Planning Kit (048.901) is recommended to help determine the most suitable abutment.

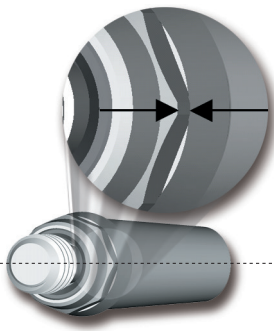
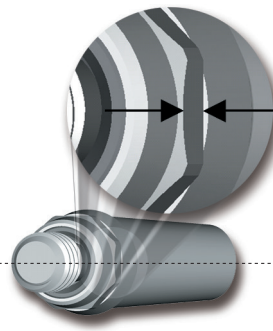
Type A		Type B	
			
Art. No. 048.612 15°	Art. No. 048.617 20°	Art. No. 048.613 15°	Art. No. 048.618 20°
			
A = angle to the apex		B = angle to the flat wall	

Option: Plastic Shoulder for RN synOcta® 15° and 20° Angled Abutments



A special Plastic Shoulder with a snap-on mechanism (048.676V4) is available for modelling the framework. The Modeling Aid is made of a burn-out plastic. Simply put the shoulder on the Plastic Shoulder of the analog until the snap-on mechanism clicks audibly into place. Modeling can be carried out using wax or plastic, and can be used for transocclusal screw-retained and cement-retained crowns and bridges.



Art. No. 048.676

A-1) Fabricating a transocclusal screw-retained single crown

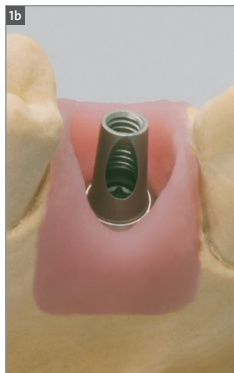

Step 1—Align the abutment on the working model and hand-tighten the abutment screw using the SCS Screwdriver.

Important: The abutment must be properly positioned in the octagon of the implant before the screw is hand-tightened.

Tip: Once the correct position has been determined, it is recommended that the position on the model is marked with a felt-tip pen to ensure that the original position is immediately recognizable when the abutment is removed.

During the modeling process, the lateral opening must be sealed with a material that can be easily removed (wax, gutta-percha, modeling resin, silicone).

Important: This seal must be removed once the crown is completed.

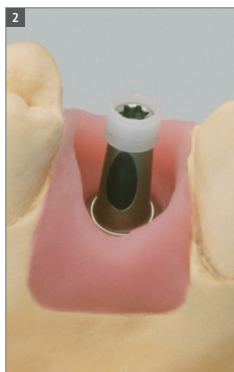

Step 2 – Attach the plastic Extension Shell (048.670) to the abutment with an SCS Occlusal Screw and shorten occlusally or adapt individually. The screw head should always be out of occlusion in order to prevent any possible riveting of the screw head. The Extension Shell must always be used since this contains the screw seating and is required for screw retention.

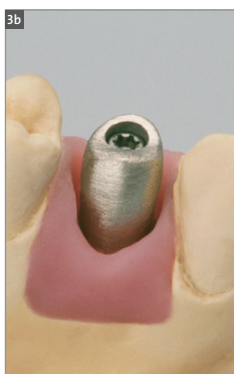
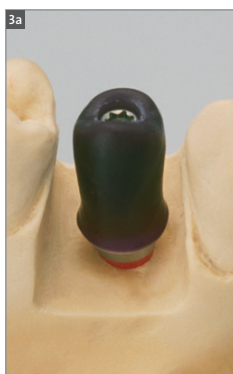

Step 3 – Model and cast the framework.

The snap-on mechanism of the Plastic Shoulder must be removed after casting (for example carefully with a polishing rubber under the microscope).

Carry out veneering in accordance with the anatomical guidelines and allow for the premolarization in the lateral region. The “freedom in centric” concept should be used for the occlusion (see page 69).

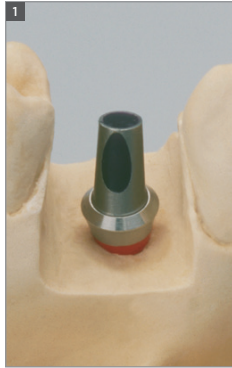

A-2) Fabricating a cemented single crown

Step 1 – In this case, the occlusal opening must also be sealed (e.g. composite, gutta-percha, silicone), in addition to the lateral opening.

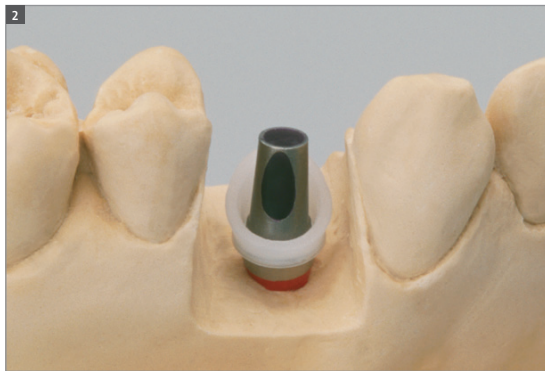

Step 2 – Positioning the Plastic Shoulder with snap-on mechanism (048.676V4), for RN synOcta® 15° and 20° Angled Abutments.

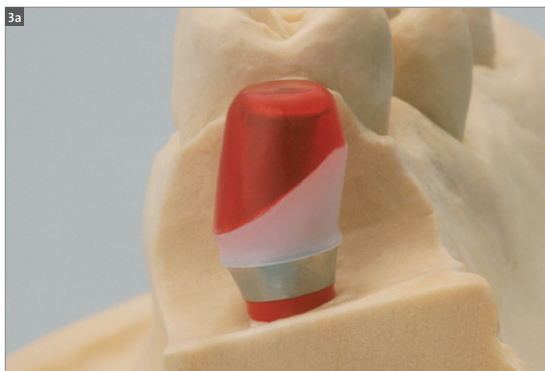

Step 3 – Model and cast the framework. Carry out veneering in accordance with the anatomical guidelines and allowing for the premolarization in the lateral region.

The “freedom in centric” concept should be used for the occlusion (see page 69).

Important: Before delivery of the work to the dentist, the lateral seal of the screw opening must be removed, to ensure that no residue is left, and the abutment must be cleaned.

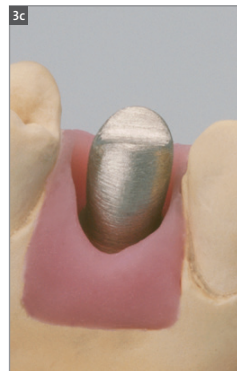
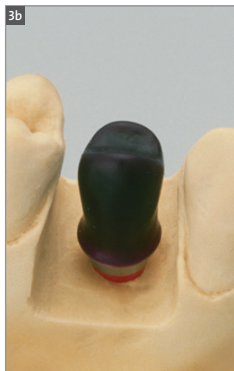



Art. No. 048.000V4 for RN synOcta® angled, short, Art. No. 048.612/613/617/618



Art. No. 048.002V4 for RN synOcta® angled, long, Art. No. 048.610/611/615/616

B) Transfer Aids

To ensure correct transfer of the position of the RN synOcta® Angled Abutments from the master cast to the patient, the Transfer Aid can be used. It is made from polymerizable plastic.

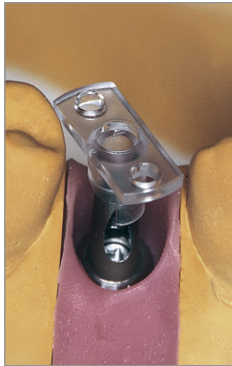

It can be placed on the RN synOcta® Angled Abutment and secured with the SCS Occlusal Screw (048.350).

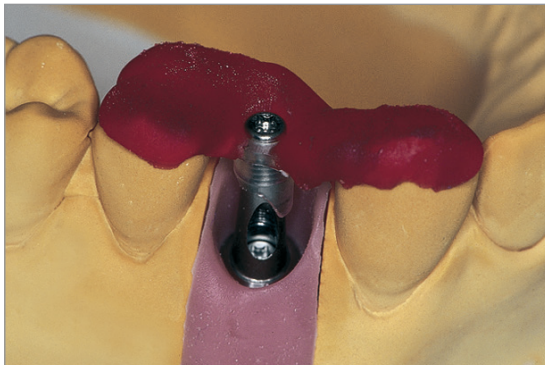

An index is fabricated using plastic. In the case of a bridge, the Transfer Aids can be splinted. Support from adjacent teeth is then not required. If space is tight, the retention elements of the Transfer Aid can be shortened.

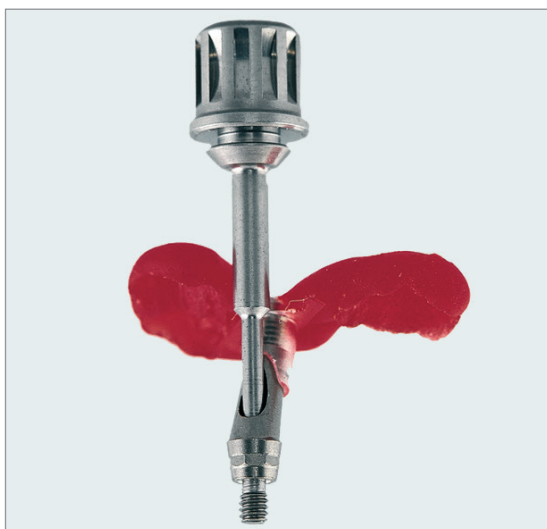

C) Fitting the final restoration

The restoration is delivered to the dentist with the original abutment on the master cast. Loosen the abutment using the SCS Screwdriver and remove it from the analog. Then place the abutment in the patient's mouth using the Transfer Aid. Finally, remove the Transfer Aid and fit the superstructure.

Important: The cleaned RN synOcta® abutment is properly positioned in the internal octagon without the use of cement.



The abutment screw is tightened with the SCS Screwdriver along with the Ratchet (046.119) and Torque Control Device (046.049).

Important: The abutment must be properly positioned in the octagon of the implant before the screw is tightened.

A tightening torque of 35 Ncm is recommended for inserting the abutments.

Tighten the crown with a torque of 15 Ncm using an SCS Occlusal Screw or an SCS Guide Screw shortened to occlusal level.

Important: If the superstructure is cemented, the lateral and the occlusal openings must be re-sealed with wax or gutta-percha.

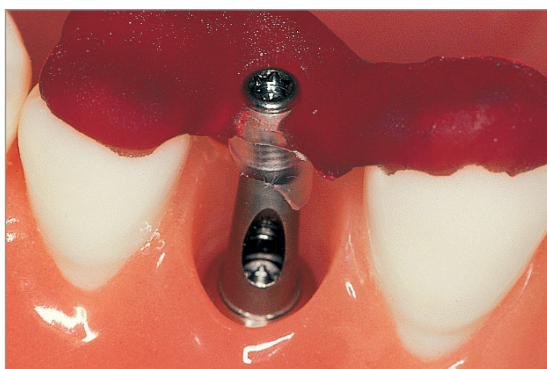

9.d synOcta® Angled for WN

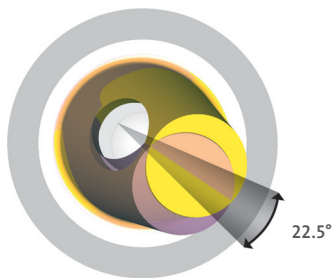





15° Angled Abutment for cement-retained crowns and bridges

The WN synOcta® 15° Angled Abutment allows prosthetic restorations to be performed while equalizing the implant axis at the same time. Only cement-retained crowns and bridges can be fabricated with the WN Angled Abutment.

Selecting the correct abutment

Two types of WN synOcta® 15° Angled Abutments are available. This enables the axis to be corrected in 16 different alignments (in 22.5° graduations).

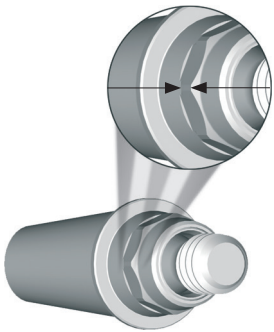
The use of the Prosthetic Planning Kit (048.901) is recommended to help determine the most suitable abutment.

Type A	Type B
 <p>Art. No. 048.608</p>	 <p>Art. No. 048.609</p>
	
A = angle to the apex	B = angle to the flat wall

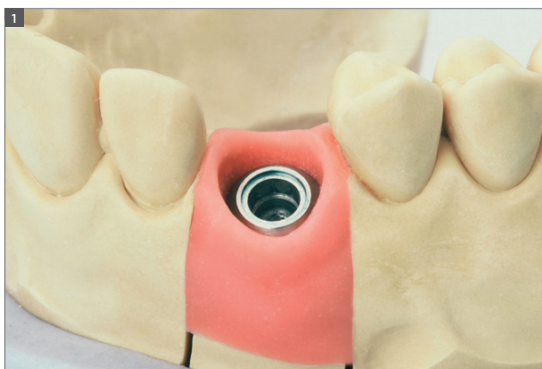

A) Fabricating a cement-retained single crown

Step 1 – Align the abutment on the working model and tighten the abutment screw using the SCS Screwdriver.

Important: The abutment must be properly positioned in the octagon of the implant before the screw is tightened.

Tip: Once the correct position has been determined, it is recommended that the position on the model is marked with a felt-tip pen in order to ensure that the original position is immediately recognizable when the abutment is removed.

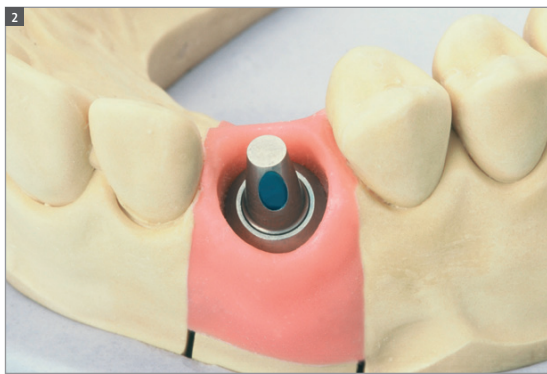

Step 2 – During the modelling process, the lateral opening must be sealed with a material that can be easily removed (e.g. wax, gutta-percha, modelling resin, silicone).

Important: This seal must be removed once the crown is completed!



Art. No. 048.678

Option: Plastic Shoulder for WN synOcta® 15° Angled Abutment
There is a special Plastic Shoulder with a snap-on mechanism (048.678) for modeling the framework. The Modeling Aid is made of a burn-out plastic.

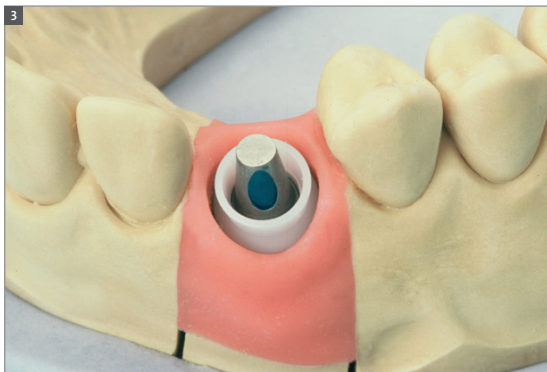

Step 3 – Simply place the shoulder on the WN analog shoulder until the snap-on mechanism clicks audibly into place.



Step 4 – Simply place the shoulder on the WN analog shoulder until the snap-on mechanism clicks audibly into place.



Step 5 – This is followed by casting of the framework. The snap-on mechanism of the Plastic Shoulder must be removed after casting (for example carefully with a polishing rubber under the microscope).
Important: Before delivery of the work to the dentist, the lateral seal of the screw opening must be removed, ensuring that no residue is left, and the abutment must be cleaned.



Art. No. 048.032

B) Transfer Aid

To ensure correct transfer of the position of the WN synOcta® Angled Abutment from the master cast to the patient, the Transfer Aid (048.032) can be used.

It is made from polymerizable plastic.



The Transfer Aid is placed on the abutment.



Fabricate an index using plastic. In the case of a bridge, the Transfer Aids can be splinted. Support from adjacent teeth is then not required. If space is tight, the retention elements of the Transfer Aid can be shortened.



C) Fitting the final restoration

The restoration is delivered to the dentist with the original abutment on the master cast. Loosen the WN synOcta® Angled Abutment using the SCS Screwdriver and remove from the analog. Place the abutment in the patient's mouth using the Transfer Aid. Finally, remove the Transfer Aid and fit the superstructure.

Important: Properly position the cleaned abutment in the internal octagon without the use of cement.



Tighten the abutment screw with the SCS Screwdriver along with the Ratchet (046.119) and Torque Control Device (046.049).

Important: The abutment must be properly positioned in the octagon of the implant before the screw is tightened.

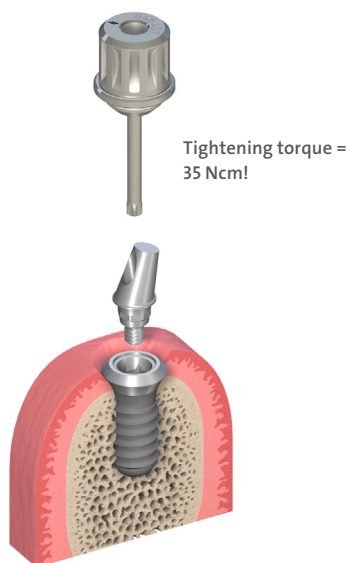

A tightening torque of **35 Ncm** is re-commended for inserting the abutment.



Important: Before cementing the superstructure, the lateral opening must be re-sealed with wax or gutta-percha.

9.e synOcta® Transversal (TS for RN)

Abutment for Transversal Screw-retained crowns and bridges

Transversal Screw retention is used in cases where occlusal/incisal screw retention is contraindicated due to reasons of esthetics and/or construction (axial alignment of the screw).



Art. No. 048.620

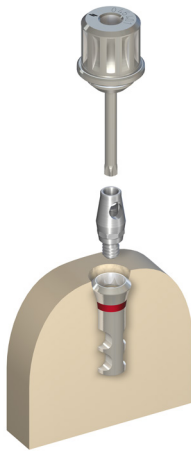

A) Fabrication of the superstructure

Inserting of the abutment

Put the original abutment on the RN synOcta® Analog and align in the octagon.

Important: The abutment must be properly positioned in the octagon before the screw is tightened.

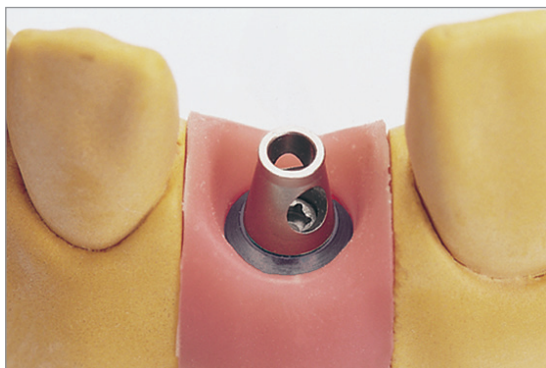

The abutment screw is tightened by hand using the SCS Screwdriver. The transversal opening can be aligned in 16 different positions.

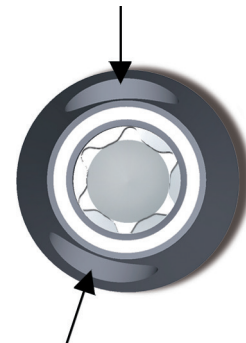
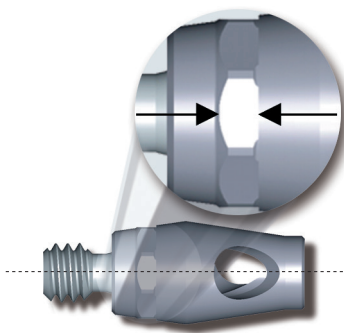
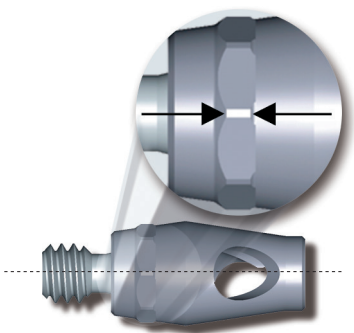

One screw opening is aligned with the flat wall, while a second screw opening is aligned with the apex.

View from above



Tip: Once the correct position has been determined, it is recommended that the position on the model is marked with a felt-tip pen to ensure that the original position is immediately recognizable when the abutment is removed.

B) Processing of the copings

The following copings are available for the RN synOcta® Transversal (TS) Abutment:



Art. No. 048.634
RN synOcta® TS Gold Coping

Version 1: Gold Coping for the cast-on technique

The Gold Coping is made of a non-oxidizing high-fusing alloy (Ceramicor®: Au 60%, Pt 19%, Pd 20%, Ir 1%; melting range 1400–1490 °C, 2552–2714 °F).

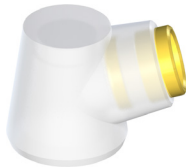

Art. No. 048.665
RN synOcta® TS Plastic Coping
with cast-on threaded housing

Version 2: Plastic Coping for the burn-out technique

The Plastic Coping is made of a burn-out plastic with a cast-on high gold content screw housing (Ceramicor®: Au 60%, Pt 19%, Pd 20%, Ir 1%; melting range 1400–1490 °C, 2552–2714 °F).

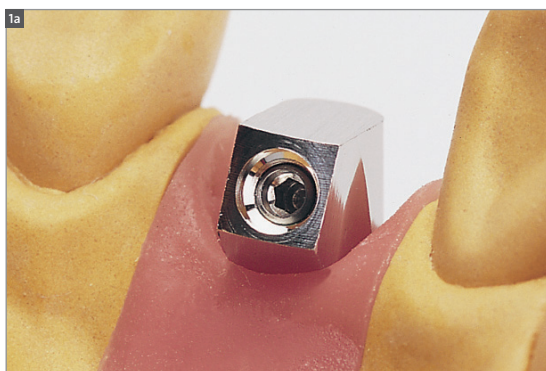

Step 1 – Position the selected coping and then carefully tightened with a Transversal Screw (049.154) and the TS Hexagonal Screwdriver (046.420).

Important: The lingual/palatal part of the Gold Coping or the lingual/palatal edge of the threaded housing must not be modified prior to casting. Otherwise, the margin of the Thread Protection Screw will no longer fit.

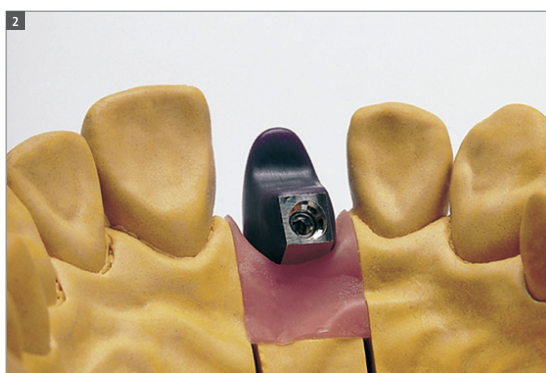

Step 2 – Wax up the framework in the conventional manner for veneers (plastic/porcelain). Use the silicone key of the wax-up to check the framework shape.

The modeling is carried out on a scaled-down tooth shape. The crowns must be premolarized in size to reduce the risk of nonaxial loading and prevent plaque accumulation due to overcontouring.



Important: Do not cover the delicate margin of the copings with wax!



Step 3 – When waxing up the framework, ensure that those areas of the prefabricated Gold Copings that are to be veneered with porcelain are coated with wax (at least 0.7 mm). As the Gold Coping consists of a non-oxidizing alloy, the porcelain cannot be bonded directly onto it (no oxidation for bonding).

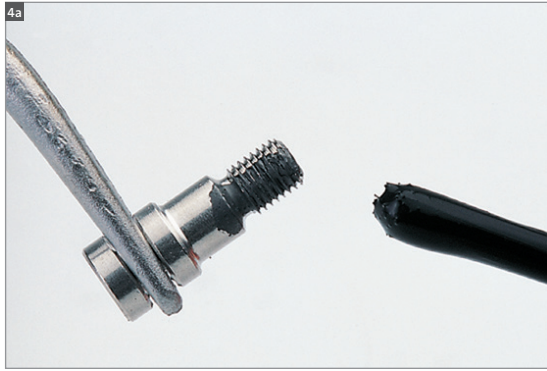

Step 4 – The screw thread must be protected during the casting phase. In order to do so, the Transversal Screw must be removed and replaced by the RN synOcta® TS Thread Protection Screw (048.672) prior to investment.



Important: Coat the thread of the Thread Protection Screw and coping with graphite before tightening it. This will allow the Thread Protection Screw to be removed more easily after the casting process.



Step 5 – Invest the modeled superstructure.



Tip: When investing a RN synOcta® TS Plastic Coping or Gold Coping, ensure that the Thread Protection Screw is facing sideways or downwards (see picture above). That way, the investment material can flow better into the inner thread channel and avoid bubbles. See casting tips on pages 64–66.

The investment material must be matched to the alloy used (refer to the manufacturer's instructions and recommendations).

Important: Prior to investment, the inside and outside of the circular gold or plastic margin must be cleaned of insulating material and wax particles. The use of investment material for rapid heating methods (speed investment methods) is not recommended. Do not use wetting agents.



Step 6 – Cast-on technique for prefabricated Gold Copings:

Since casting is always involved with the RN synOcta® TS Copings (casting to the screw housing in the case of Plastic Copings), the guidelines on cast-on technique on pages 64–66 must be followed.

Once the model has slowly cooled to room temperature, carefully remove the investment compound.



Step 7 – The following are suitable for devesting:

Ultrasound, water, pickling or a glass fiber brush.

Important: Never use sand-blasting for devesting.

This will destroy the margins and adversely affect the accuracy of the fit.

Casting defects inside the Gold Copings are due to differences in the expansion behavior between Ceramicor® and the investment material. They considerably affect the precision of the prefabricated parts and jeopardize the entire restoration (follow investment material manufacturer's directions).

If there is a small amount of metal or casting defects on the thread, the thread can be worked smooth with the Tap for TS (044.570).

Tip: If the thread of the Thread Protection Screw breaks during removal because of the metal, the remainder of the thread can be loosened in an acid bath containing 32% concentrated hydro-chloric acid (over night, for instance).

If there are small casting beads on the shoulder of the Plastic Copings, the shoulder area can be smoothed using the Finishing Instrument. Position the Guide Pin and Finishing Instrument in the cast coping and smooth the margin by rotating the Finishing Instrument slowly and evenly.



The following items are required:

1. synOcta® Guide Pin, 046.241, 2. Finishing Instrument for 45° shoulder, 046.243, 3. Handle, 046.240

Serious casting defects and extreme unevenness cannot be corrected with the Finishing Instrument and Tap. In these cases, the procedure must be repeated.

Important: The Finishing Instrument has no stop. Abrade only as much as necessary to remove the casting beads. Working under a stereo microscope is recommended.

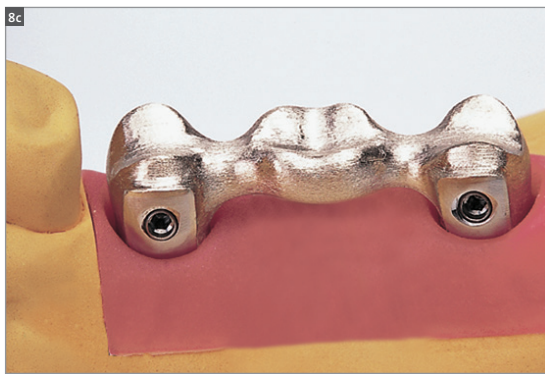
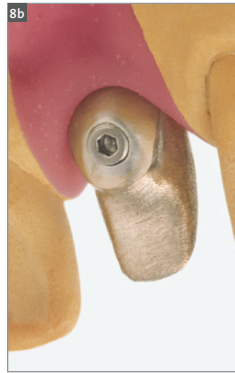

Step 8 – When trimming the framework, ensure that the burn-out alloy is not ground off or perforated. Exposed areas of the prefabricated Gold Coping or threaded housing may cause the porcelain to crack (no oxide layer for bonding and differences in the thermal expansion behavior of Ceramicor® and porcelain).

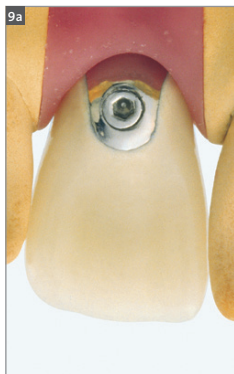

Step 9 – Carry out veneering in accordance with the anatomical guidelines and allow for the premolarization in the lateral region. The “freedom in centric” concept should be used for the occlusion (see page 69).





Note: As the prefabricated copings are extremely precise, the margins must be finished and polished with extreme care. Working under a stereo microscope is recommended.



Tip: A RN synOcta® Analog can be attached to protect the margins during polishing. This reduces the risk of damage to the margins.



Art. No. 048.003V4

C) Transfer Aid

To ensure correct transfer of the position of the RN synOcta® Transversal (TS) Abutment from the master cast to the patient, the Transfer Aid (048.003V4) can be used.

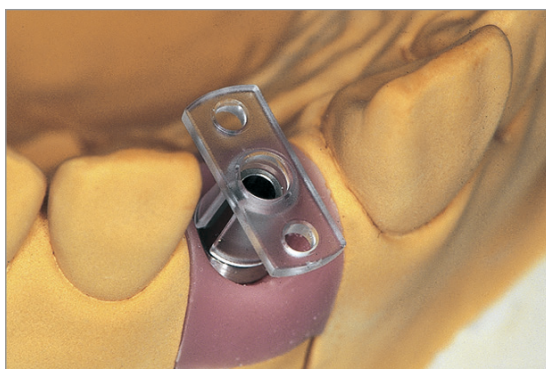

It is made from polymerizable plastic and is placed on the RN synOcta® Transversal (TS) Abutment.



Fabricate an index using plastic. In the case of a bridge, the Transfer Aids can be splinted. Support from adjacent teeth is then not required.

If space is tight, the retention elements of the Transfer Aid can be shortened.

D) Fitting the final restoration

The restoration is delivered to the dentist with the original abutment on the master cast.



Remove the Healing Cap or temporary restoration. Thoroughly clean and dry the interior of the implant.

Remove the RN synOcta® Transversal (TS) Abutment from the master cast using the SCS Screwdriver.



Fit the abutment intraorally using the Transfer Aid.



Then remove the Transfer Aid and fit the superstructure.



Important: Properly position the cleaned RN synOcta® Transversal (TS) Abutment in the internal octagon without the use of cement.

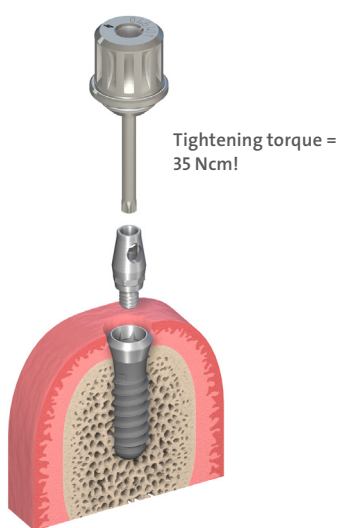

Tighten the abutment screw with the SCS Screwdriver along with the Ratchet (046.119) and Torque Control Device (046.049).

Important: The abutment must be properly positioned in the octagon before the screw is tightened.

A tightening torque of 35 Ncm is recommended for inserting the abutments.



Insert the superstructure using the Transversal Screw, and tighten carefully by hand using the TS Hexagonal Screwdriver (046.420).



Art. No. 046.420



9.f Straumann® CARES® Implant-borne prosthetics

Customized implant prosthetics

Straumann® CARES® CAD/CAM offers you a range of implant-borne prosthetic solutions in order to achieve high-quality dental implant restorations. Straumann® CARES® implant-borne elements are designed for high reliability and predictability.

All implant-borne prosthetic solutions can be ordered via Straumann® CARES® Visual software. Straumann® CARES® Abutments can also be ordered via the Straumann® CARES® Scan & Shape service.

Straumann® CARES® Abutments

For customized patient solutions

- For cement-retained crowns and bridges via mesostructure
- For screw-retained crowns (ceramic abutments only)
- Available in two different materials: titanium and ceramic

• Characteristics

- Customized shape and emergence profile
- Control over cement gap
- Proven Straumann precision fit

Straumann® CARES® Screw-retained Bridges and Bars

For complex customized patient solutions

- For screw-retained bridges
- For bars (Dolder®, MP-Clip®, Ackermann®, round)
- In two different materials: titanium Grade 4 and cobalt-chromium alloy (coron®)

• Characteristics

- Direct connection to the implant, no additional abutment needed
- High precision

For further information regarding Straumann® CARES® Implant-borne prosthetics, please see brochure *Straumann® CARES® Implant-borne prosthetics, Basic Information* (152.822/en).



10 synOcta® Gold Abutment for RN and WN

The customizable one-piece solution for anterior zone esthetics

Indication and product overview

As an easy-to-process one-piece solution, the synOcta® Gold Abutment for direct cast-on procedures simplifies production by substantially reducing required handling steps. With the option to create a screw or cement-retained restoration, the synOcta® Gold Abutment offers the prosthetic versatility needed to achieve individual and esthetic results.

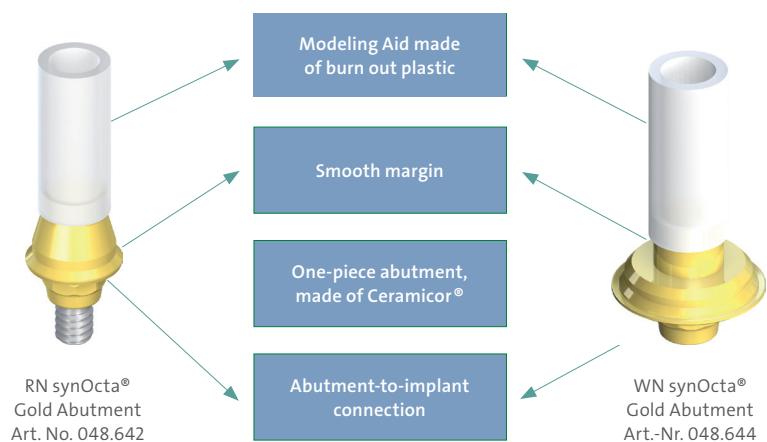

The synOcta® Gold Abutment has an octagon in the basal portion that joins with the octagon of the Straumann dental implant to prevent it from rotating. It is intended for use with screw-retained single-crown restorations or as a customized meso structure for cementretained crowns and bridges. The Gold Abutment is not suitable for direct splinting to another Gold Abutment. Single restorations with a screw access hole through the occlusal/cingulum surface may be fabricated. The screw channel of burn-out plastic is attached to the Gold Abutment to optimize any modification. The use of a synOcta® 1.5 Screw-retained Abutment (048.601 or 048.603) is not necessary.

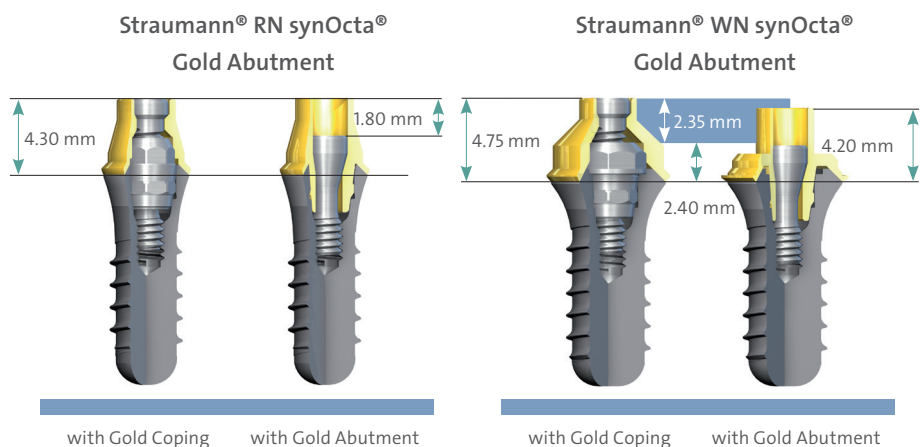

The use of the WN synOcta® Gold Abutment (048.644) is equivalent to the RN synOcta® Gold Abutment (048.642).

For detailed instructions refer to the following step-by-step procedure of the RN synOcta® Gold Abutment.

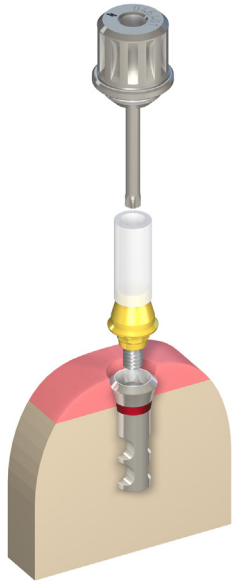

A) Production of the meso structure

Inserting of the abutment

The RN synOcta® Gold Abutment is placed on the analog and aligned in the internal octagon.

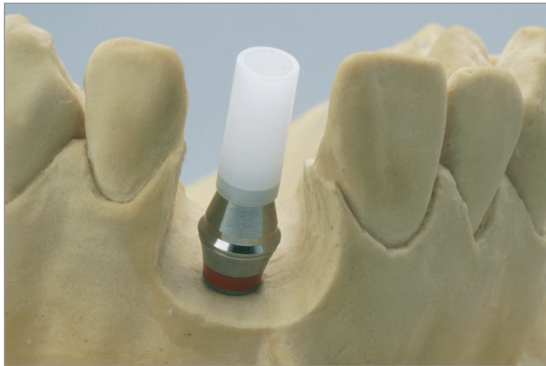

Important: The abutment must be positioned in the internal octagon before the internal screw is tightened. The screw is tightened by hand using a SCS Screwdriver.



Tip: A gingival mask should always be used to ensure that the emergence profile of the crown is optimally contoured. This is essential for restorations in esthetically demanding regions and with subgingival crown margins.

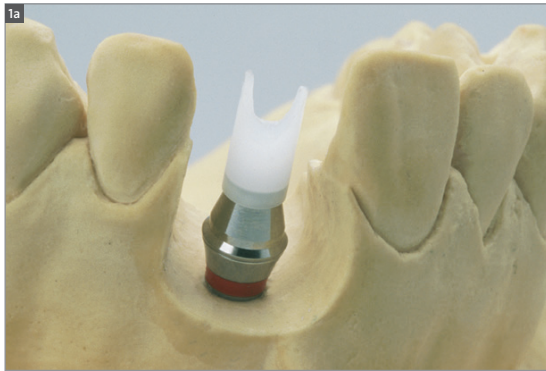

Processing of the Gold Abutment

Step 1 – Depending on the individual circumstances, the Modeling Aid can be shortened to the height of the occlusal plane.



Tip: For easier handling of the abutment the use of an additional analog is recommended for manipulation outside the model.

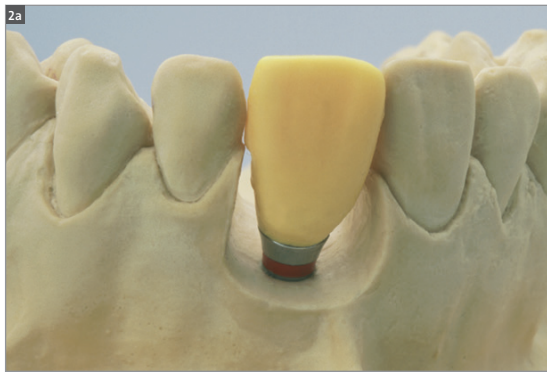

Step 2 – For optimal esthetic planning, a wax-up can be modeled.



Step 3 – Then a silicone key will be made over the wax-up to define the optimal wax modelation for the customized abutment.

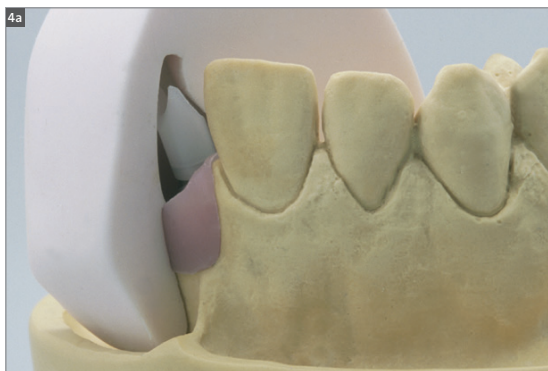

Step 4 – A wax modelation is contoured according to the anatomical circumstances of the individual case.

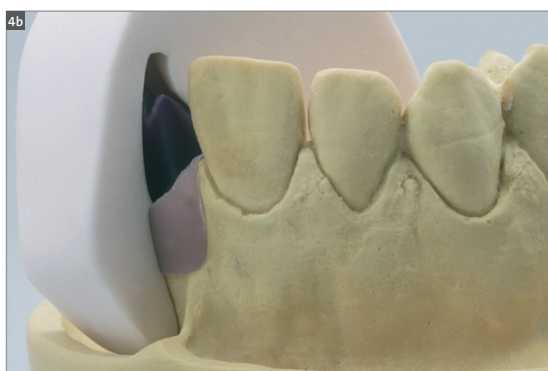

The silicone key shows exactly the space for the cement-retained crown, which will be made over this customized abutment.



Note: The modeling on the abutment must be sufficiently thick (wax layer of at least 0.7 mm). Do not cover the delicate margin of the abutment with wax. The Modeling Aid ensures a clean and sharp-edged finish of the screw channel.

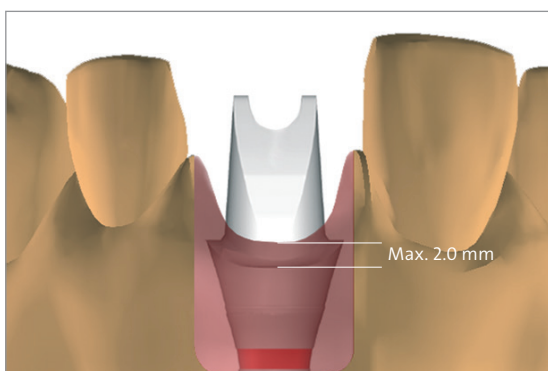

The picture shows an optimal design for fabrication of the customized abutment for contouring of an ideal emergence profile and adaptation of the margin to the gingival contour.

For reasons of hygiene, the cement margin must lie no deeper than 2.0 mm below the gingiva.



Step 5 – Invest the customized abutment in the usual method **without** the use of wetting agents.

In order to avoid overflow of the cast-on alloy on the delicate circular edge and interior of the abutment, it is recommended to thoroughly clean the abutment prior to investment (removal of wax particles, insulating agents with a cotton pellet and/or brush moistened **with alcohol**).



Warning: Ensure that there is no wax on the delicate margin! The use of investment materials for rapid heating methods (speed investment materials) is not recommended! When processing the investment material, follow the investment material manufacturer's instructions. Observe the recommended mixing ratio and preheating time exactly!

Tip: Always do the cast with the Modeling Aid. Otherwise the dental casting alloy will not or only too thinly flow out at the upper coping rim.



Step 6 – Casting the customized abutment. Gentle deinvestment with ultrasound, water jet, pickling acid or glass fiber brush.



Note: Intruded casting metals and casting pearls cannot be removed from the shoulder part of the Gold Abutment with the reamer instrument for the 45° shoulder due to design reasons.

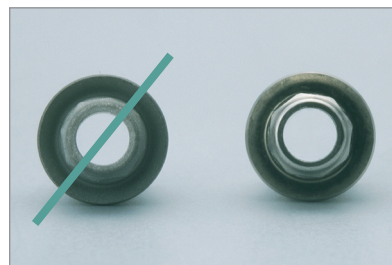

Warning: Never use sand-blasting for deinvestment, as it will destroy the abutment.

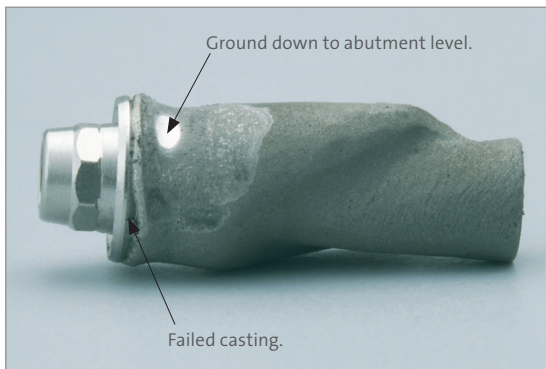

Casting errors and incorrect handling

If the cast-on alloy is trimmed through, the Ceramicor® surface cannot be covered with ceramic veneer and the cast has to be redone. Ceramicor® is a non-oxidizing alloy and allows no ceramic bonding.

Note: If you choose to veneer directly onto the RN synOcta® Gold Abutment, you have to ensure that you have a sufficient metal thickness of the dental casting alloy.

In the case of casting errors like insufficient mold fill, casting beads or casting defects in the interior, the procedure **must be repeated**. The long-term success of the implants depends greatly on the precision of fit of the restoration.

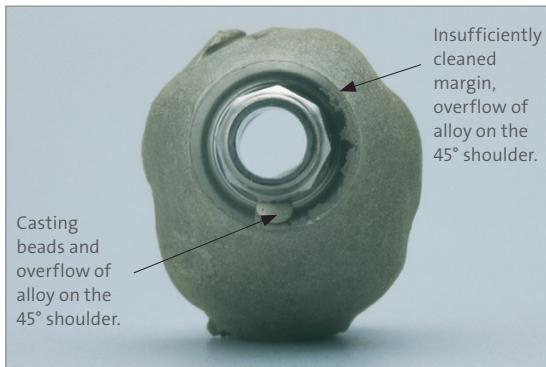

Step 7 – After trimming, the finished customized abutment is polished and ready for the fabrication of the cement-retained single crown.

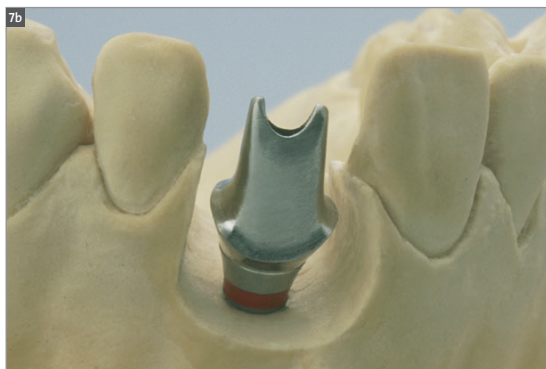

B) Fabricating the cement-retained single crown

Step 1 – After blocking out the screw channel the framework is waxed directly over the customized abutment.

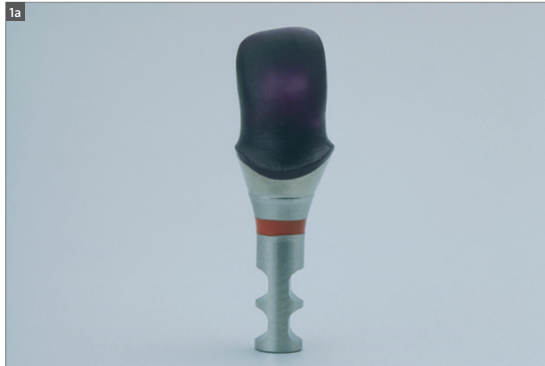

Step 2 – The silicone key shows the spatial relations for the restoration.



Step 3 – Cast the framework in the conventional manner.





Step 4 – After the trimming of the cast, the metal crown fits precisely on the customized abutment.

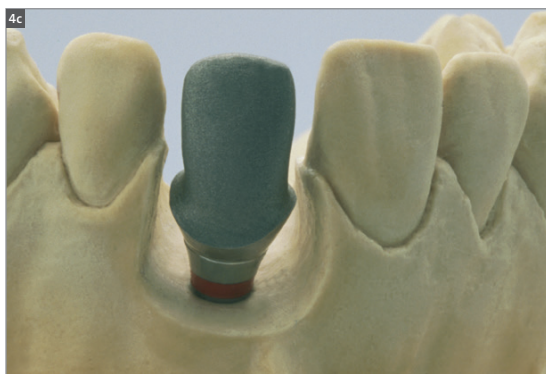

Step 5 – The silicone key shows the spatial relations for the veneering.

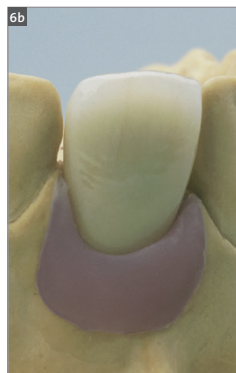

Step 6 – The final cement-retained crown on the individualized abutment.

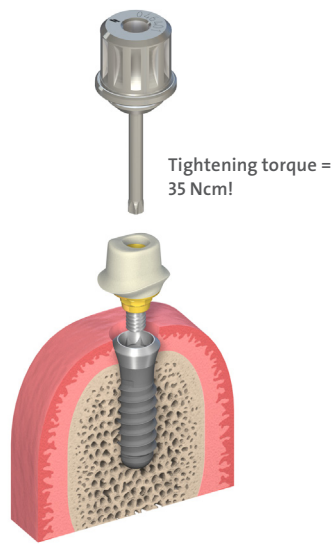

C) Fitting the final restoration

The restoration is delivered to the dentist with the customized abutment on the master cast. The cleaned customized abutment must be positioned in the internal octagon of the implant without the use of cement. The Basal Screw of the RN synOcta® Gold Abutment is then tightened to **35 Ncm** on the implant using an SCS Screwdriver, Ratchet (046.119) and Torque Control Device (046.049).

Before cementing the crown, the SCS configuration of the occlusal screw should be closed with cotton and sealing compound (gutta-percha). This allows the possibility of later removal of the customized abutment in case a crown replacement becomes necessary.

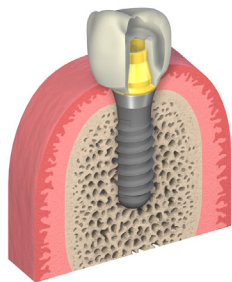

Then the final restoration will be definitively cemented on the customized abutment.

11 Processing instructions

Investing and casting

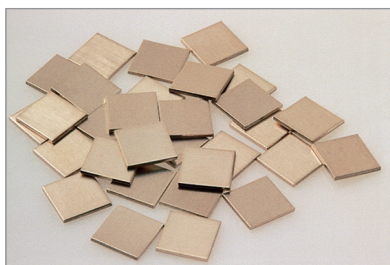

Casting tips for burn-out Plastic Copings

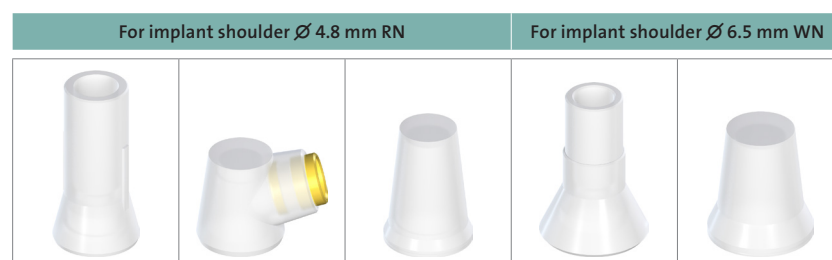

Casting the framework

The success of work carried out with prefabricated plastic components depends on the attention paid to the following points:

- Burn-out plastics are characterized by the fact that they swell up when they are burned out. For that reason it is important that the outside of the Plastic Coping is completely covered with wax. The wax burns off and therefore creates sufficient space in the mold for expansion when burned out in the oven. There must be a wax layer of at least 0.3 mm in the marginal region (**Caution:** Do not wax above the delicate margin). If there is insufficient waxing in the marginal region of the coping, there is a risk that the frustum will break in the interior of the invested coping (screw channel), due to the effects of the expansion of the plastic in the mold.
- To avoid casting errors due to wax particles, insulating agents, etc., careful cleaning of the interior and the inside and outside of the delicate edge of the coping prior to investment (e.g. with a cotton bud soaked in alcohol) is recommended.
- The sprues must encourage elimination of the wax and plastic and must not impede the direction of flow of the alloy (i.e. there should be no sharp angles and edges). Follow the investment material manufacturer's recommendations on the selection and positioning of sprues.

- Do not use wax wetting agents, if possible. The plastic is so smooth that the investment material will fill all the fine contours of the coping's interior very well during investment (with the aid of a fine blunt instrument or a fine brush). However, if wetting agents are utilized, ensure that no aggressive wetting agents are used which could attack the surface of the Plastic Copings. Then blow-dry the copings carefully with compressed air. Wetting agent residues can lead to a reaction with the investing material and thus to casting errors.
- To avoid air bubbles or casting beads in the case of occlusal screw-retained Plastic Copings, ensure that the investment material flows through the screw channel into the interior of the coping. If it flows directly into the interior, this can lead to the formation of bubbles.
- The use of phosphate-bonded investment materials that allows a staged burn-out is recommended. These must be matched with the alloy used.
- When processing the investment material, follow the investment material manufacturer's instructions. Observe the recommended mixing ratio and preheating times exactly.
- The use of investment material for rapid heating methods (speed investment methods) is not recommended.
- Use only high gold content alloys, and refer to the alloy manufacturer's alloy tables.

Casting tips for prefabricated Gold Copings (Ceramicor®)

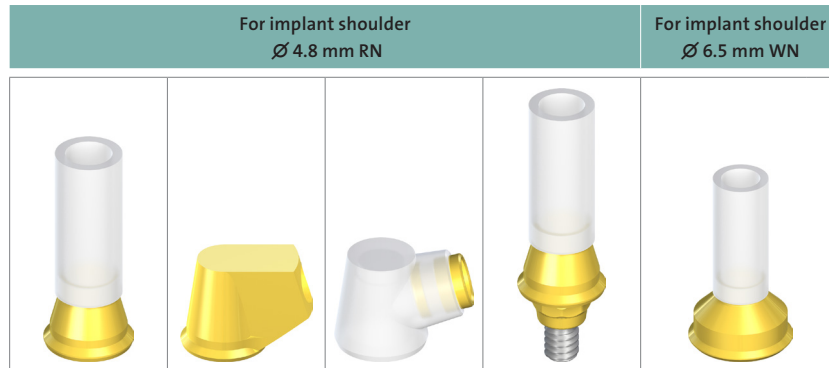

Casting the framework

- Do not use wax wetting agents, if possible. The fine film of the wax wetting agent on the surface of the gold during casting can result in metal on the 45° shoulder or in the interior (also see casting tips for burn-out plastics, pages 64–65). In this case, the work has to be repeated, as the long-term success of the implants greatly depends on the accurate fit of the prosthetic work.
- In order to avoid overflow of the cast-on alloy on the delicate circular edge and interior of the gold/Plastic Copings, it is advisable to clean them prior to investment (removal of wax particles, insulating agents, for instance, with a cotton bud soaked in alcohol).
- The sprues must encourage elimination of the wax and plastic and must not impede the direction of flow of the alloy (i.e. there should be no sharp angles and edges). Follow the investment material manufacturer's recommendations on the selection and positioning of the sprues.
- The use of phosphate-bonded investment materials is recommended. These must be matched to the alloy used.
- When processing the investment material, follow the investment material manufacturer's instructions. Observe the recommended mixing ratio and preheating times exactly.
- The use of investment materials for rapid heating methods (speed investment materials) is not recommended.



Guidelines for creating reliable cast-on joints

Alloy remarks concerning castable Ceramicor® components:

No ceramic can be bonded directly to cast-on Ceramicor® components as this alloy does not form bonding oxides. Ceramicor® is only suitable for cast-on procedures.

Recommendation: When selecting the casting or bonding alloy, ensure that it is compatible with the high-fusing alloy of the Ceramicor® components. The melting range of this casting alloy must not exceed a liquidus temperature of 1350 °C/2462 °F.

Suitable dental casting alloys:

- High noble alloys
- Precious metal alloys with a minimum content of gold and platinum group metals of 25 %
- Palladium based alloys with a minimum content of palladium of 50 %

Ceramicor® must not be cast on with base metal casting alloys, because gold in combination with nickel or cobalt causes destruction of the components!

Alloys in accordance with ISO 9693, 1562 und 8891 are suitable for casting procedures with prefabricated Ceramicor® components.

The alloy manufacturer's recommendations must be followed. Due to "diffusion" at the alloy/Gold Coping interface, components made from an unsuitable alloy may form phases with low strength, reduced corrosion resistance or a lower melting range.

Compression/contraction, casting stresses:

The spur angles and casting ratios must be such that the fusion temperature of the metals is attained. This should be ensured particularly in the case of large-volume solid casts (e.g. WN cast objects).

Cast on properly
The cast-on alloy has fused with the
Ceramicor® coping.

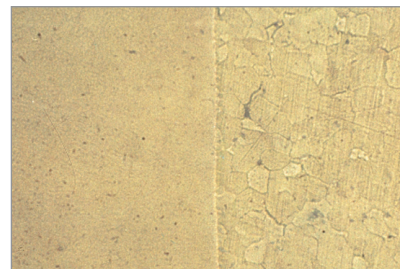

▲
Ceramicor® coping

▲
Cast-on alloy

Cast on inadequately
The inadequate diffusion and variable
solidification are clearly visible

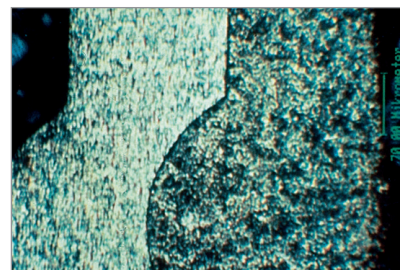

▲
Ceramicor® coping

▲
Cast-on alloy

General casting tips for all copings (Plastic Copings and Gold Copings)

Casting Procedure

The mold must be transferred to the casting machine in the shortest time possible.

Careful deinvesting

Once the mold has slowly cooled to room temperature, carefully remove the investment material from the cast object. The following are suitable for deinvesting: ultrasound, water jet, pickling or a glass fiber brush.

Never use sand-blasting for deinvesting.

This would destroy the fine margins and the internal configuration (octagon), which would lead to reduced accuracy of the fit (poor marginal fit and rotation of the copings).

If casting errors occur, such as insufficient discharge, casting beads or casting defects in the interior, the procedure must be repeated, as the long-term success of the prosthetic work depends greatly on the accurate fit of the restoration.

Important: Casting defects considerably affect the precision of the prefabricated parts and jeopardize the long-term success of the restoration. The work then has to be repeated.

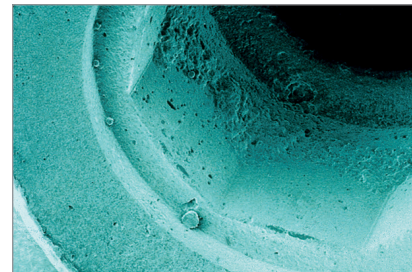

Trimming the cast

When using prefabricated Gold Copings, ensure that the bonding alloy is not ground off or perforated when trimming the framework. Exposed areas of the prefabricated Gold Coping may cause the porcelain to crack (no oxide layer for bonding and differences in the thermal expansion behaviour of Ceramicor® and ceramic).

Carry out veneering in accordance with the anatomical guidelines and allow for the premolarization. When building up the porcelain, the framework should be fixed to the master cast with the SCS Guide Screws. This allows the porcelain to be stacked around the screw. The “freedom in centric” concept should be used for the occlusion.

Natural teeth are elastically connected to the alveolar bone via the periodontium. In contrast, implants are held rigidly as they undergo ankylosis with the bone. Loads exerted on implant-borne crowns and bridges are transmitted directly to the bone. Wherever possible, these loads should be transmitted during physiological movement, i.e. by correct occlusion, as the integrated implants may be disturbed by an inadequate occlusal surface.

The “freedom in centric” concept therefore affords an ideal solution to occlusion with implant borne bridgework. “Freedom in centric” involves the creation of an area of approximately 1.0 mm², which permits lateral freedom of approximately 1.0 mm in habitual intercuspitation. This surface allows the cusps to glide smoothly between the retruded contact position and maximum intercuspitation. The position of maximum intercuspitation is considered to be the centric occlusion.

The possibility of performing masticatory movements with the described tolerance allows certain regulatory movements to be made in the restored dentition. This, together with premolarization, prevents overloading. Extreme cusp formation must be avoided as this may lead to severe interlocking and consequently to overloading.

Vertical masticatory forces must be exerted as physiologically as possible on the implant-antagonist axis. Crowns on single tooth implants should not perform guide functions. The degree to which this is possible should be decided at the treatment planning (diagnostic wax-up) stage.

As the prefabricated copings are extremely precise, the margins must be finished and polished with great care. Working under a stereo microscope is recommended.

Tip: A Polishing Protector (046.245) or an analog can be attached to protect the margins during polishing. This reduces the risk of damage to the margins.

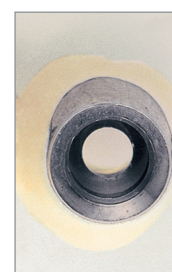

Material Information

Alloy			Ceramicor®	
Color			White	
Composition	Au Pt Pd Ag Cu Ir other	% % % % % % + = <1%	60.0 19.0 20.0 1.0	
Melting range			°C °F	1400–1490 °C 2552–2714 °F
Heat expansion coefficient	WAK		°C °F	25–500 °C = 11.9 µm/m 2 °C 25–600 °C = 12.2 µm/m 2 °C 77–932 °F = 11.9 µm/m 2 °F 77–1112 °F = 12.2 µm/m 2 °F
Hardness condition (by delivery)	HV5		220	
Hardness after casting or soldering	HV5		205 Self-hardening	
Hardened	HV5		205	
0.2% proof stress (Rp 0.2%) condition as delivered	N/mm²		780	
0.2% proof stress (Rp 0.2%) after casting or soldering	N/mm²		635	
Possibilities for metal bonding			Casting or soldering	
Technical information Applications			Non-oxidizing alloy for casting-on with precious metal alloys or for soldering with precious metal and non-precious metal alloys.	

Sterilization

Straumann abutments and components are not sterile when delivered. Please use the following procedure for sterilization prior to use.

Material	Method	Conditions
Ti, Ti alloy, PEEK, PEEK with Ti inlay	Autoclave, moist heat	134 °C (273°F), 5 min

Note: Parts that have been modified or altered from their original state may require different sterilization procedures.

Patient recall

Implant-borne superstructures require optimal oral hygiene on the part of the patient. This must be considered by all involved when planning and designing the superstructure.

The following points require special attention:

- precise marginal fit between implant and superstructure
- open accessible interdental spaces (to encourage oral hygiene)
- self-cleaning posterior pontics, if possible
- the use of a gingival mask on the master cast assists the dental technician when designing the critical areas of the superstructure
- avoid excessive contouring (e.g. a “ridge lap”) which would impede hygiene procedures and/or expose the implant/restoration to stress

Implant-borne superstructures must undergo regular check-ups to detect any damage or loosening of screws at an early stage.

If oral hygiene is poor, the patient should be re-instructed and motivated at the next scaling and polishing session. The interval between check-ups can be extended for cooperative patients with good oral hygiene.

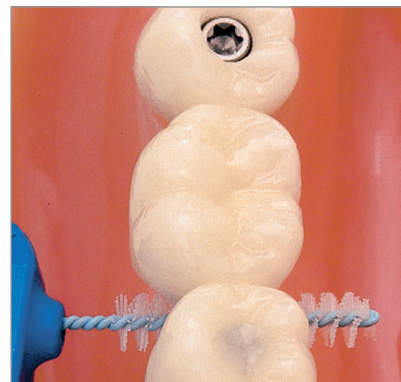

References

References are available upon request.

Please contact your Straumann representative.

Documentation

For more information, please refer to the following brochures:

- *Straumann Product Catalog* (452.200/en)
- *Cement-retained Crowns and Bridges with the Solid Abutment System* (152.254/en)
- *Retentive Systems for Implant-borne hybrid dentures* (152.252/en)
- *Prosthetic Procedures for the Narrow Neck CrossFit® Implant* (152.808/en)

Courses and training

Courses

Please ask your Straumann representative for information about Straumann® Dental Implant System training courses. For further information, please visit our homepage at www.straumann.com.

Training ensures long-term success!

Custom-made products

Under certain circumstances, custom-made products can be supplied for special indications or cases, which cannot be treated with standard products.

A custom-made product is defined according to EC guideline 93/42 (Article 1, § d) as being any product fabricated specifically for a specific patient according to specific characteristics and prescribed in writing by a properly qualified doctor, who assumes the responsibility.

If you require a custom-made product, please contact your customer service representative.

Quality at the customer's service

"We want our customers, rather than our products, to come back."

Although we did not coin this phrase (unfortunately!), it does provide an accurate description of our quality assurance policy.

Directives

93/42/EEC

All production stages carried out by Institut Straumann AG are subject to the standards laid down in the EN ISO 9001 quality assurance system. This European standard establishes in detail the criteria which, in order to be recognized, a company must fulfil regarding comprehensive quality assurance during its manufacturing processes.

Medical products have to meet extremely strict requirements, and with good reason. These requirements are defined in the European standard ISO 13485, which we also fulfill. This ensures that the quality of our products and services meets our customer's expectations and can be reproduced and traced at any time.

Our products comply with all the basic requirements defined in the Medical Devices Directive 93/42/EEC. Our medical products therefore carry the CE mark.

Institut Straumann AG fulfills the stringent requirements of the European Directive 93/42/EEC for medical devices as well as the EN ISO 9001 and ISO 13485 standards.

12 Important guidelines

Please note

Practitioners must have appropriate knowledge and instruction in the handling of the Straumann CAD/CAM products or other Straumann products ("Straumann Products") for using the Straumann Products safely and properly in accordance with the instructions for use.

The Straumann Product must be used in accordance with the instructions for use provided by the manufacturer. It is the practitioner's responsibility to use the device in accordance with these instructions for use and to determine, if the device fits to the individual patient situation.

The Straumann Products are part of an overall concept and must be used only in conjunction with the corresponding original components and instruments distributed by Institut Straumann AG, its ultimate parent company and all affiliates or subsidiaries of such parent company ("Straumann"), except if stated otherwise in this document or in the instructions for use for the respective Straumann Product. If use of products made by third parties is not recommended by Straumann in this document or in the respective instructions for use, any such use will void any warranty or other obligation, express or implied, of Straumann.

Availability

Some of the Straumann Products listed in this document may not be available in all countries.

Caution

In addition to the caution notes in this document, our products must be secured against aspiration when used intraorally.

Validity

Upon publication of this document, all previous versions are superseded.















Documentation

For detailed instructions on the Straumann Products contact your Straumann representative.

Copyright and trademarks

Straumann® documents may not be reprinted or published, in whole or in part, without the written authorization of Straumann. Straumann® and/or other trademarks and logos from Straumann® mentioned herein are the trademarks or registered trademarks of Straumann Holding AG and/or its affiliates.

Explanation of the symbols on labels and instruction leaflets

-  Batch code
-  Catalogue number
-  Sterilized using irradiation
-  Lower limit of temperature
-  Upper limit of temperature
-  Temperature limitation
-  Caution: Federal law restricts this device to sale by or on the order of a dental professional.
-  Do not re-use
-  Non-sterile
-  Caution, consult accompanying documents
-  Use by
-  Keep away from sunlight
-  Straumann Products with the CE mark fulfill the requirements of the Medical Devices Directive 93/42 EEC
-  Consult instructions for use

International Headquarters

Institut Straumann AG

Peter Merian-Weg 12

CH-4002 Basel, Switzerland

Phone +41 (0)61 965 11 11

Fax +41 (0)61 965 11 01

www.straumann.com

MP-Clip® is a registered trademark licenced to Cendres+Métaux Holding SA, Switzerland. Dolder® is a registered trademark from Prof. Eugen Dolder, exclusively licenced to Cendres+Métaux Holding SA, Switzerland. Ackermann Bar® is a registered trademark licenced to Cendres + Métaux Holding SA, Switzerland. Ceramicor® is a registered trademark of Cendres+Métaux SA, Switzerland. IPS e.max® is a registered trademark of Ivoclar Vivadent AG, Liechtenstein. VITA CAD-Temp® is a registered trademark of VITA Zahnfabrik H. Rauter GmbH & Co. KG.

© Institut Straumann AG, 2018. All rights reserved.

Straumann® and/or other trademarks and logos from Straumann® mentioned herein are the trademarks or registered trademarks of Straumann Holding AG and/or its affiliates. All rights reserved.